

Name: Urban PF/120

Design: Joana Bover / 2011

Typology: Ceiling lamp







Environment: Indoor

Technical description:

Ceiling lamp releasing diffused light through a chrome fixture with hand wrapped translucent polyester blend ribbon. The frosted polycarbonate diffuser is included, and clients can choose among white, cream or red ribbon options.



**Lamps description**

-  Grounding: compulsory
-  6 x 36 W 2G11 Twin CFL
- Voltage: 120-277 V / 50-60 Hz
-  1 Box 49.21 x 49.21 x 17.72 inches
- Vol.: 24.830 ft<sup>3</sup>
- Weight: 77.16 lbs
- Certifications:  
-  Photometrics made according to the position the lights are shown in the catalogue and price list.

Ref	Finishings
0332506BU	Chrome White Translucent Ribbon
0332506CU	Chrome Cream Translucent Ribbon
0332506RU	Chrome Red Translucent Ribbon
D0332506BU	DIM 0-10V / Chrome White Translucent Ribbon
D0332506CU	DIM 0-10V / Chrome Cream Translucent Ribbon
D0332506RU	DIM 0-10V / Chrome Red Translucent Ribbon

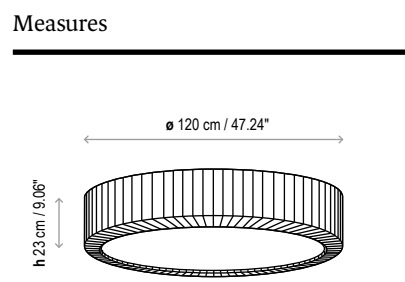

\* Dimming ballast (DIM 0-10V)

---

Customizable

Urban PF/37

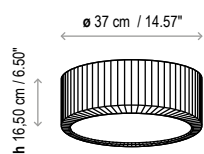

Urban PF/60

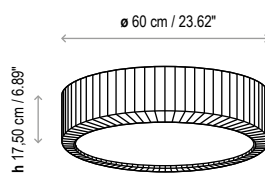

Urban PF/90

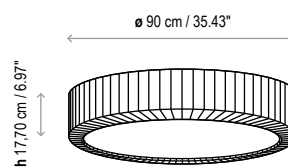

Urban PF/120

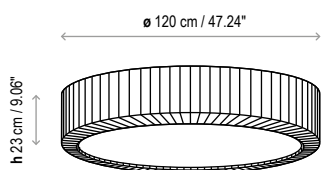

Urban S/37

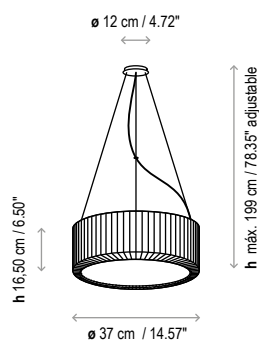

Urban S/60

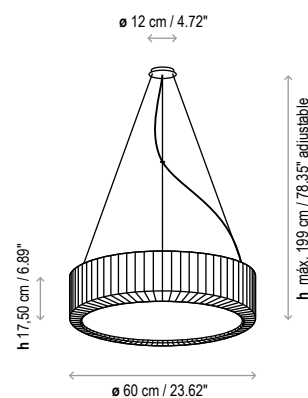

Urban S/90

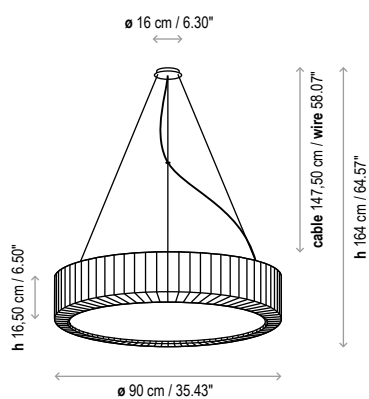

Urban S/120

