

kreon

technics

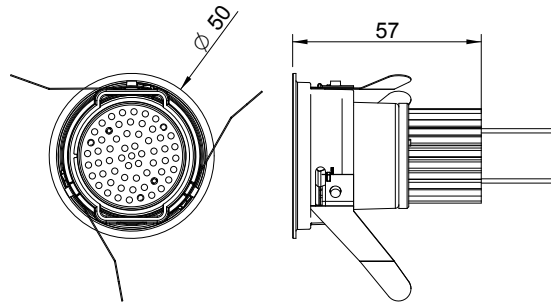

Name
Aplis 40 fixed
Aplis 40 WW

Reference
KR95703X-XXXX-XXX
KR95733X-XXXX-XXX

Drive current
700mA
700mA

The luminaire must not under any circumstances be covered with heat insulating covers or similar materials.
Cables must not touch the luminaire housing.
The connection cable must be routed so that it does not touch the lamp when the luminaire is tilted.

1 dimensions

in case of platerboard ceiling

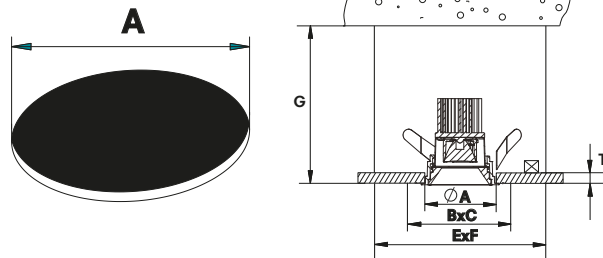

Name	Reference	A	ExF	G _{min}	T _{min} -T _{max}
Aplis 40 fixed	KR95703x, KR96703x, KR97703x, KR98703x	∅ 45	110x110	80	9-26
Aplis 40 WW	KR95733x	∅ 45	110x110	80	9-26

Please make sure that main voltage is disconnected before proceeding! ⚡

2 cut out

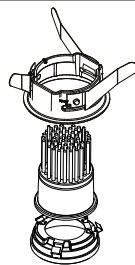

Remove louvre and module.

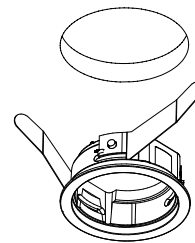

Fold the springs against the ring and rotate anti clockwise to insert into the ceiling.

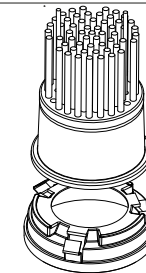

Put the module on the louvre to install the module.

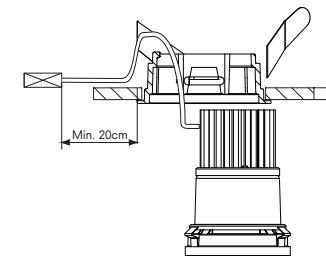

In case of transformer or ballast.

3 installation

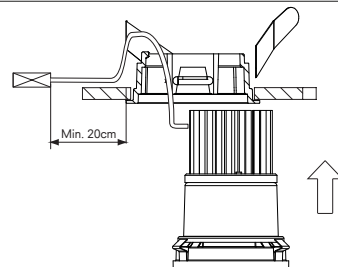

Put the assembly in the plasterkit until the louvre clicks, see also manual KR8170001761.

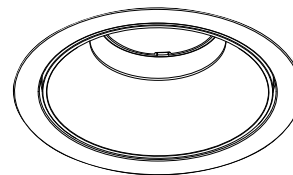

Lightbeam In case of WW

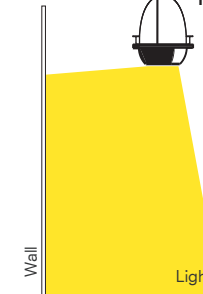

Fixed



WW

4 installation

Industrieweg Noord 1152
3660 Oplabbeek/Belgium

Tel + 32 89 81 97 80
Fax + 32 89 81 97 90

www.kreon.com
mailbox@kreon.be

revision date:08-05-2017
KR8570302048

Sheet 1/1