

COUNTRY – 082.14.OV IL FANALE

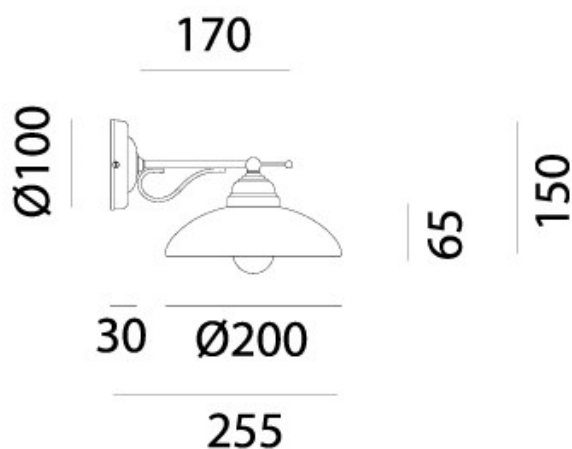

Linguaggio country internazionale e tradizione millenaria del vetro di Murano, grande espressione del made in Italy, si fondono alla perfezione nella collezione Country. Prodotte in ottone e vetro soffiato bianco, queste lampade sono particolarmente caratterizzate dal bordo ribruciato marrone.

International country language and millennial tradition of Murano glass, great expression of made in Italy, blend perfectly into the Country collection. Produced in brass with white blown glass, these lamps are particularly characterized by a burnt brown rim.



Tipologia: PARETE

Type: WALL LIGHT

Ambiente / Environment
INDOOR

Materiale: OTTONE - CERAMICA
Material: BRASS - CERAMIC

Finitura / Colore: OTTONE - VETRO
Finishing / Color: BRASS - GLASS

Fonte luminosa – Lighting Souce:
1x Max 46W E14

Voltaggio – Voltage
240V

Classe Energetica – Energetic Class
A++/E

PROTEZIONE IP – IP PROTECTION
IP20

PESO – WEIGHT
1Kg

Lampadina non inclusa
Light bulb not included

