

- LED projector with adjustable beam position
- Aluminium body machined from solid in 6082 alloy with surface protection treatment and subsequent polyester powder paint resistant to corrosion, atmospheric conditions and salt spray
- Thermal shock resistant tempered, extraclear, anti-glare safety glass with grinded edges
- Plastic cable gland resistant to corrosion, atmospheric conditions and salt spray. Silicone gaskets
- Stainless steel external screws. IP67 power supply in metal box included
- IP68 connector for the connection between projector and power supply included
- IP68 male ad female connectors and neoprene cable for connection extension (between projector and power supply) accessories available on request
- Spike accessory available on request
- Safety cable accessory available on request
- Maximum permissible ambient temperature + 50 °C

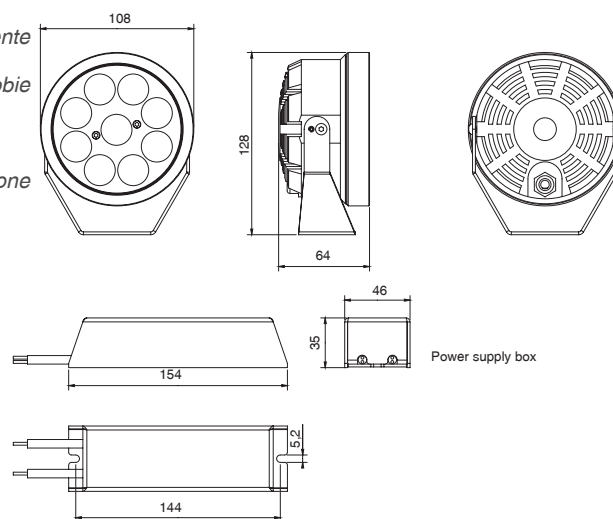

- *Proiettore LED con fascio di luce orientabile*
- *Corpo in alluminio tornito dal pieno lega 6082 con trattamento superficiale di protezione e successiva verniciatura in polvere di poliestere resistente agli agenti atmosferici, alla corrosione ed alle nebbie saline*
- *Vetro di sicurezza temperato con bordi molati, extrachiaro ed antiriflesso resistente agli shock termici*
- *Pressacavo in plastica resistente agli agenti atmosferici, alla corrosione ed alle nebbie saline. Guarnizioni in silicone*
- *Viti esterne in acciaio inox. Alimentatore IP67 in box metallico incluso*
- *Connettore IP68 per la connessione fra proiettore ed alimentatore incluso*
- *Connettori IP68 maschio e femmina e cavo in neoprene per prolunga connessione (fra proiettore ed alimentatore) accessori disponibili su richiesta*
- *Picchetto accessorio disponibile su richiesta*
- *Cavo di sicurezza accessorio disponibile su richiesta*
- *Temperatura ambiente massima ammissibile +50 °C*



Lamp / Lampada	Input / Alimentazione	Power / Potenza	Color Tolerance / Tolleranza Cromatica	CRI / CRI
PCB 9 LED CREE	220/240V 50/60Hz	12W / 24W	2-SDCM / 3-SDCM	80 MIN



NEXO LUCE (Factory)
 Strada Mirabella, 10
 46040 Cavriana (MN), ITALY
 T +39 0376 771513 F +39 0376 772235
 sales@nexoluce.com www.nexoluce.com

Made in Italy

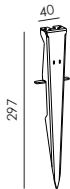
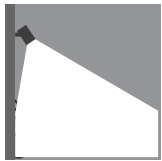
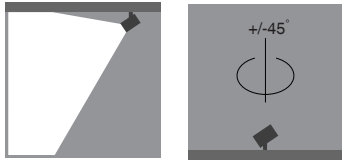
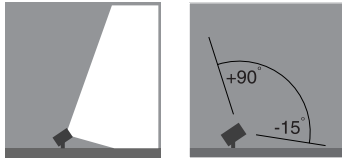

*SPIKE ACCESSORY ON REQUEST
*ACCESSORIO PICCHETTO SU RICHIESTA
code: 003.0203.C (Dark Grey/Antracite)



*SAFETY CABLE L.600MM D2,0MM ACCESSORY ON REQUEST
*ACCESSORIO CAVO DI SICUREZZA L.600MM D2,0MM SU RICHIESTA
code: 003.0222.G (Stainless Steel/Acciaio INOX)



*IP68 CONNECTORS ON REQUEST
*CONNETTORI IP68 SU RICHIESTA
code: 003.0223.0



*2x0,35 H05RN-F CABLE (1 meter) ON REQUEST
*CAVO 2X0,35 H05RN-F (1 metro) SU RICHIESTA
code: 003.0224.0

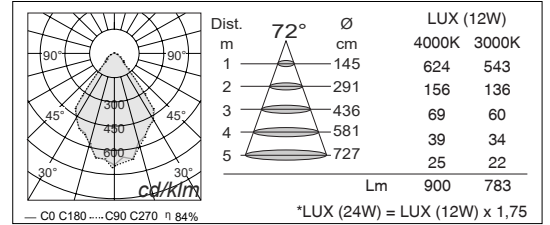
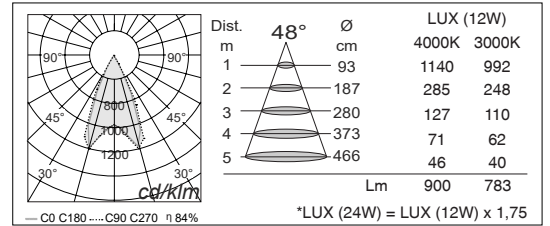
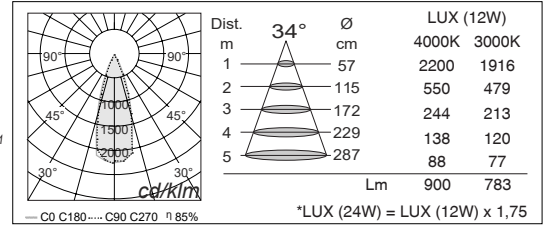
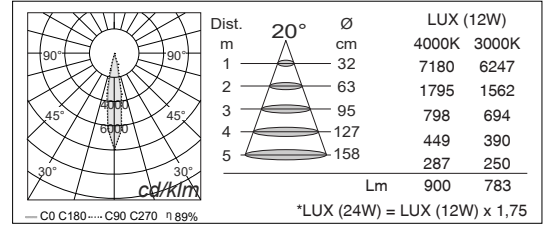
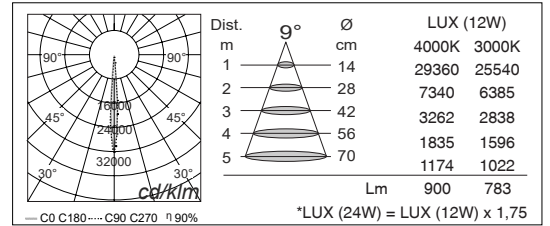

MAIN CODE CODICE BASE	RELEASE EDIZIONE	LIGHT COLOR COLORE LUCE	WATT WATT	OPTIC OTTICA	CONTROL CONTROLLO	FRAME COLOR COLORE
2616	.1	B 3000K	.12 12W	.B 9°	1 ON/OFF	.C DARK GREY / ANTRACITE
		C 4000K	.24 24W	.D 20°		
		* others on request / altri su richiesta		.G 34°		
				.I 48°		
				.K 72°		

CODE EXAMPLE : Projector with warm white light color at 3000K, 12W, 20° optic, ON/OFF control, dark grey color
2616.1B.12.D1.C

ESEMPIO DI CODIFICA : Proiettore con luce calda a 3000K, 12W, ottica 20°, controllo ON/OFF, colore antracite
2616.1B.12.D1.C

NEXO LUCE (Factory)
Strada Mirabella, 10
46040 Cavriana (MN), ITALY
T +39 0376 771513 F +39 0376 772235
sales@nexoluce.com www.nexoluce.com

Made in Italy