

BRASS & SPOTS VE 1069 S4

Design by: Studio Stile Masiero



Telaio in ottone dorato.

Gold plated solid brass frame.

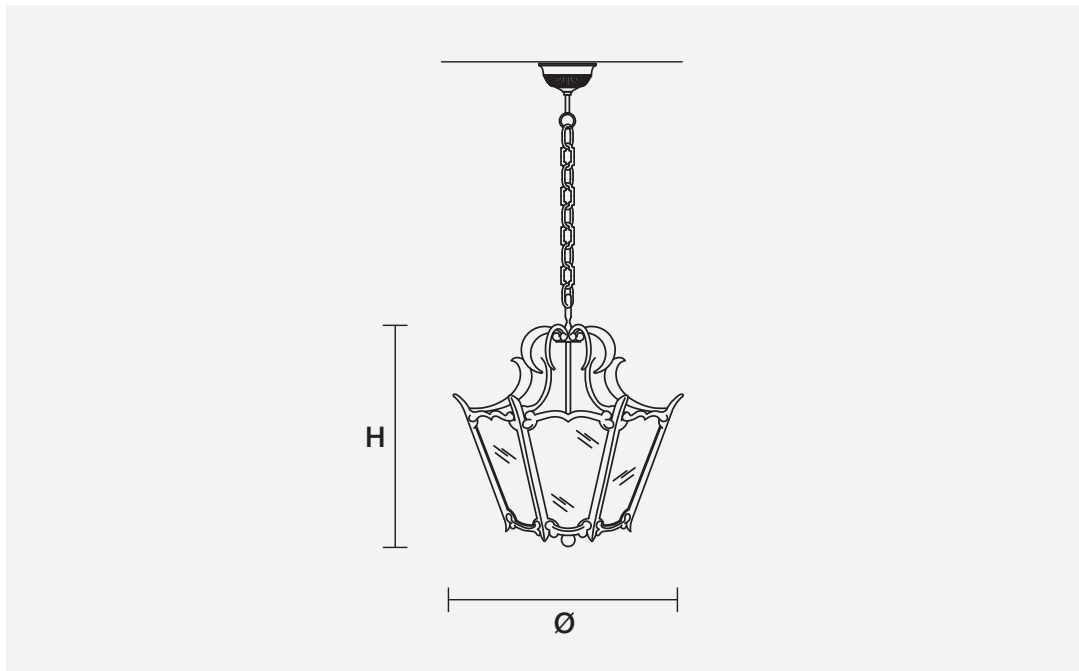

H 44 cm
17.32"

L 42 cm
16.53"

Peso: 5 kg

 4 x E14 x 40W max
Incandescenza/Incandescent



MATERIALI MATERIALS

CUT CRYSTAL

Pendagli in cristallo trasparente molato.

Pendants in transparent cut crystal.

SWAROVSKI® ELEMENTS

Pendagli in cristallo trasparente SWAROVSKI® ELEMENTS.

Pendants in transparent SWAROVSKI® ELEMENTS crystal.

HALF CUT GLASS

Pendagli in vetro semi-molato.

Half cut glass pendants.