

technics

Aplis 165 LED KR93783x-xxxx

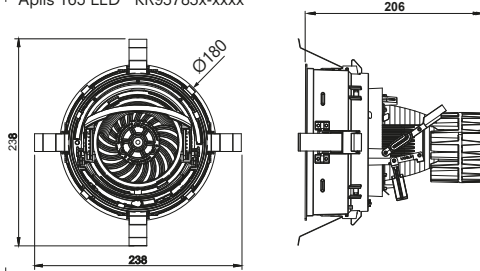

Aplis 165 LED KR93734x-xxxx

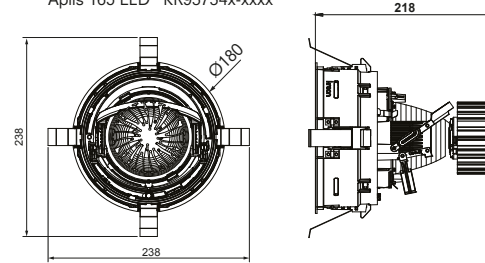

Name	Reference	current
Aplis 165 LED	KR93734x-xxxx	1050mA
Aplis 165 LED	KR93783x-83xx	700mA
Aplis 165 LED	KR93783x-98xx	500mA

The luminaire must not under any circumstances be covered with heat insulating covers or similar materials. Cables must not touch the luminaire housing. The connection cable must be routed so that it does not touch the lamp when the luminaire is tilted.

1 dimensions

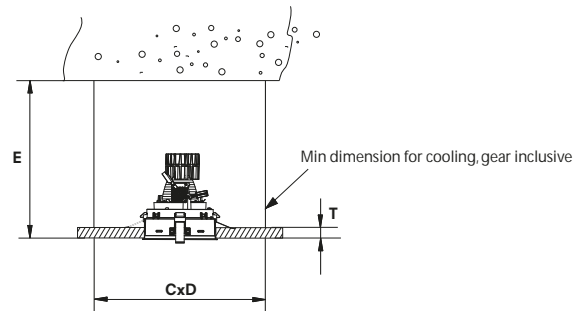

Name	Reference	Ø A	CxD	E _{min}	T _{min} -T _{max}
Aplis 165 LED	KR93734x-xxxx	175	350x350	230	
Aplis 165 LED	KR93783x-xxxx	175	350x350	250	
Plasterboard thickness					9-26

2 cut out

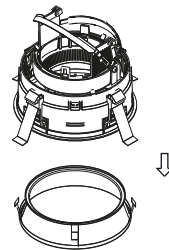

Remove louvre

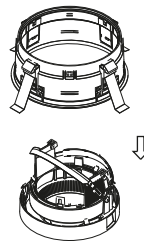

Remove directional part

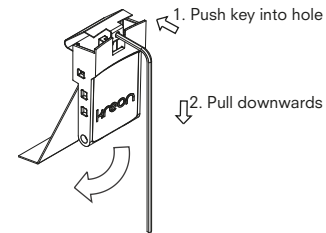

Open spring mechanism (4x) with an allen key.

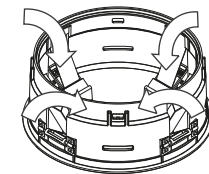

3 installation

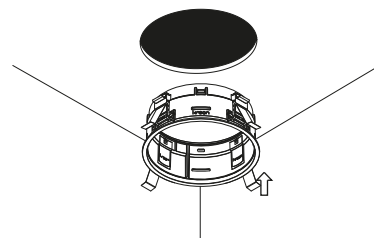

Insert installation box in the hole.

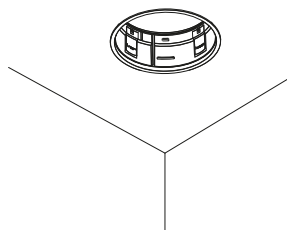

Close spring mechanism (4x).

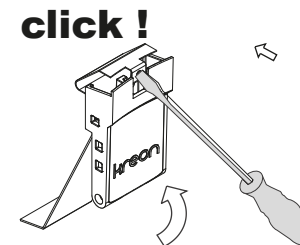

Fix the spring with a tool.

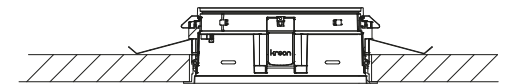

installation

technics

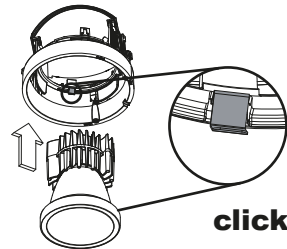
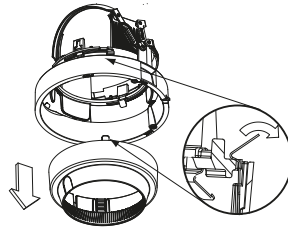
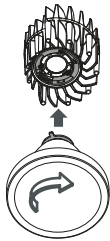

click !

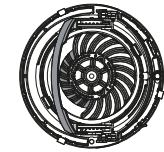
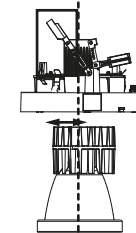

installation

install the reflector on the LED module first, the reflector is fixed by turning it on the LED, underneath the bajonet ring

Bend the springs to remove the filterholder.

insert the reflector-LED assembly in the Aplis the border of the reflector has to snap on the springs

IMPORTANT: mind the orientation of the heatsink! the shortest side of the heatsink is on the side of the aplis with the longest rod

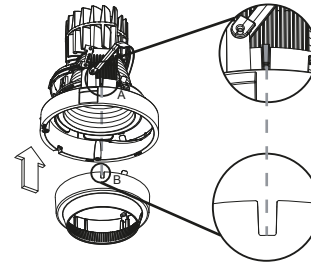
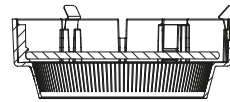
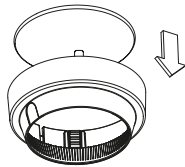

click !

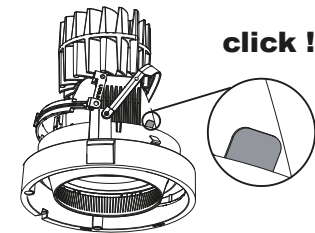

installation

Optional: add extra filter (one) to the filterholder.

Maximum capacity= one filter.
In case of wall washer see manual KR8473301854

install the filterholder again by first alining A and B

Please make sure that main voltage is disconnected before proceeding!

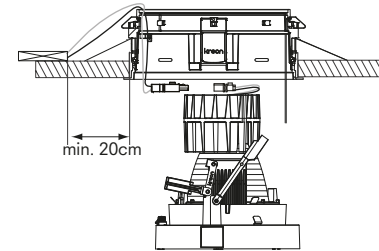
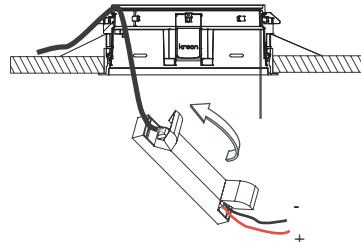

male connector is already wired as follows

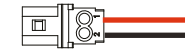

make sure the female connector is wired in the same way

2 = black
1 = red

installation

install the correct gear with strain relief on the hollow ceiling

important: always check the polarity!!
+ = red wire - = black wire

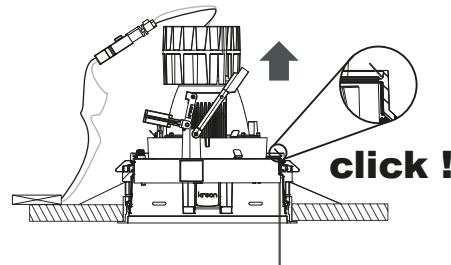
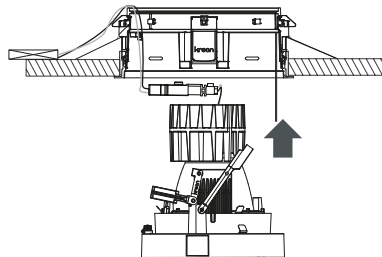

click !

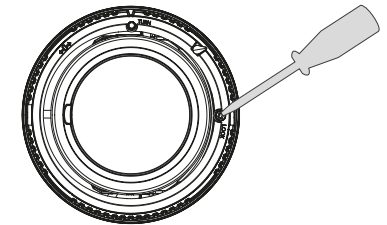

Turn 1/4 circle to lock.

installation

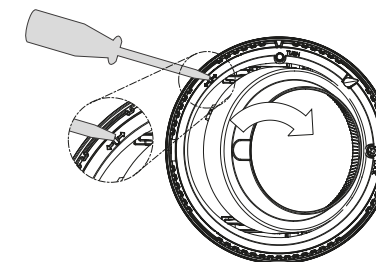
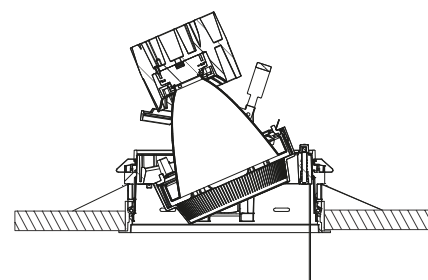
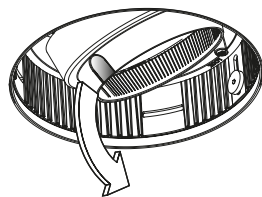
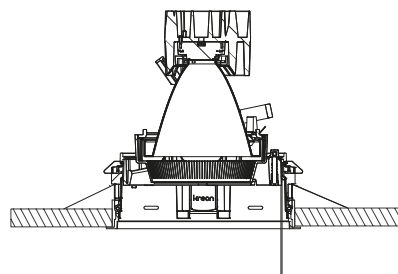

installation

Pull at the filterholder with thumb and index on the recessed surface to rotate inner part manually.

Turn inner part with tool or manually.

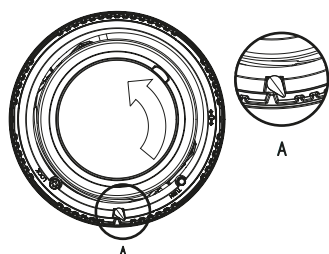

A

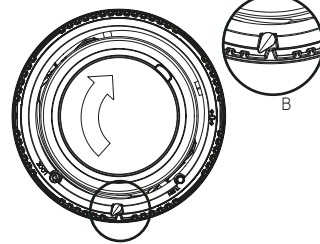

B

A

B

installation

Can rotate 360°.

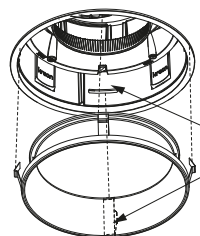

align springs with slots

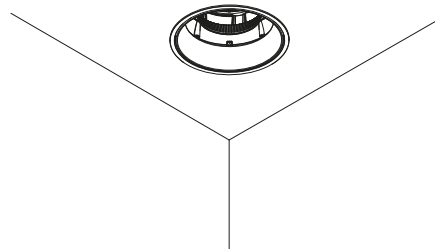

installation

Install the louvre, align the springs with the slots

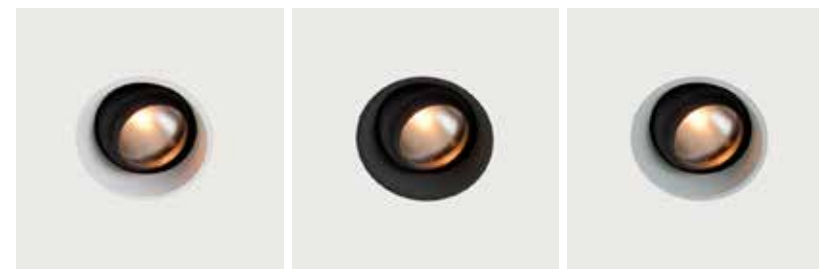

5 picture

kreon nv

Industrieweg Noord 1152
3660 Opglabbeek
Belgium

Fax + 32 89 81 97 90

www.kreon.com
mailbox@kreon.be

revision date: 31/01/2018
KR8378301850

Sheet 3/3