

TABLE LAMPS VE 1008 TL1

Design by: Studio Stile Masiero



Base in vetro di Murano soffiato e lavorato a mano, paralume in tessuto pongè.

Hand made blown Murano glass base, pongè lampshad.

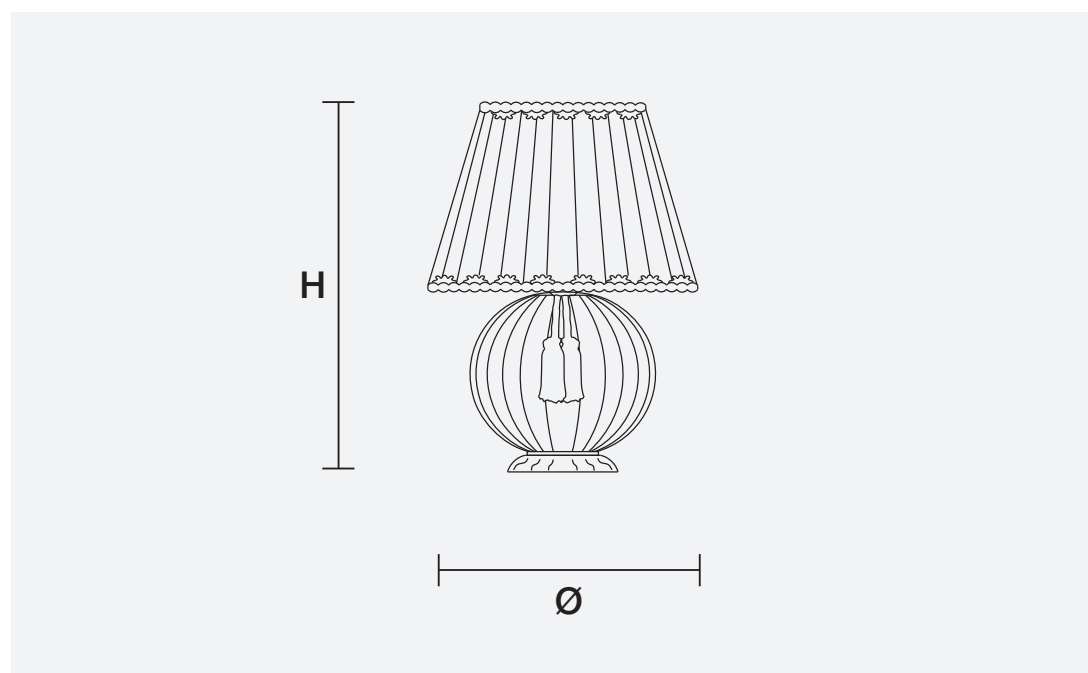

H	41 cm 16.20"
Ø	30 cm 11.90"

 1 x E27 x 60W max
Incandescenza/Incandescent



MATERIALI MATERIALS

CUT CRYSTAL

Pendagli in cristallo trasparente molato.

Pendants in transparent cut crystal.

SWAROVSKI® ELEMENTS

Pendagli in cristallo trasparente SWAROVSKI® ELEMENTS.

Pendants in transparent SWAROVSKI® ELEMENTS crystal.

HALF CUT GLASS

Pendagli in vetro semi-molato.

Half cut glass pendants.