

- Drive-over square LED Uplight
- Anodized aluminium body machined from solid in 6082 alloy
- Brushed stainless steel frame AISI 316L
- Thermal shock resistant tempered, extraclear, anti-glare safety glass with grinded edges
- Silicone gaskets
- IP67 external power supply included
- IP68 connector for the connection between projector and power supply included
- IP68 male ad female connectors and neoprene cable for connection extension (between projector and power supply) accessories available on request
- Housing for installation D80X120MM or cylindrical D38X150MM (recommended for remote power supply) available as an accessory
- Available with STAR optic (not drive-over)
- Maximum permissible ambient temperature + 50° C

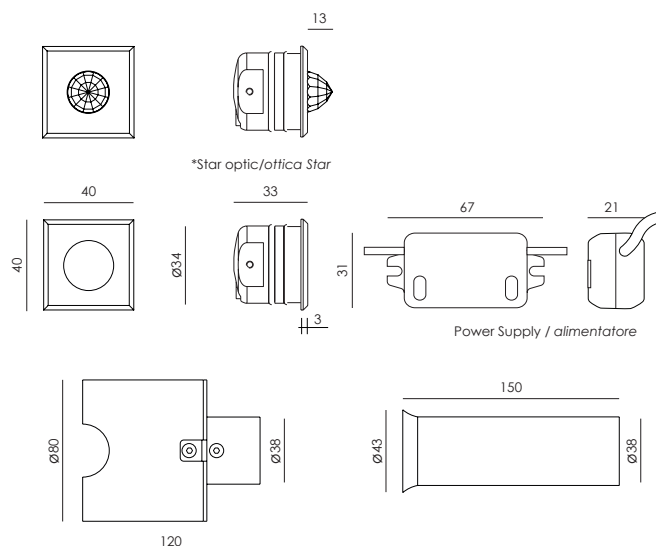

- *Proiettore LED quadrato a pozzetto carrabile*
- *Corpo in alluminio anodizzato tornito dal pieno lega 6082*
- *Cornice esterna in acciaio inox AISI 316L spazzolata*
- *Vetro di sicurezza temperato con bordi molati, extrachiaro ed antiriflesso resistente agli shock termici*
- *Guarnizioni in silicone*
- *Alimentatore esterno IP67 incluso*
- *Connettore IP68 per la connessione fra proiettore ed alimentatore incluso*
- *Connettori IP68 maschio e femmina e cavo in neoprene per prolunga connessione (fra proiettore ed alimentatore) accessori disponibili su richiesta*
- *Controcassa per installazione D80X120MM oppure cilindrica D38X150MM (consigliata per alimentatore remoto) disponibile come accessorio*
- *Disponibile con ottica STAR (non carrabile)*
- *Temperatura ambiente massima ammissibile +50° C*



Housing D80x120MM available as an accessory / controcassa D80X120MM disponibile come accessorio cod. 003.0251.0

Cylindrical housing for remote power supply available as an accessory / controcassa cilindrica per alimentatore remoto disponibile come accessorio cod. 003.0204.H



Lamp / Lampada	Input / Alimentazione	Power / Potenza	Color Tolerance / Tolleranza Cromatica	CRI / CRI
PCB 1 LED CREE	220/240V 50/60Hz	1,5 / 3 W	2-SDCM / 3-SDCM	80 MIN



NEXO LUCE (Factory)
 Strada Mirabella, 10
 46040 Cavriana (MN), ITALY
 T +39 0376 771513 F +39 0376 772235
 sales@nexoluce.com www.nexoluce.com

Made in Italy

© Nexo Luce, a company incorporated in Italy. The logo and the name are the property of Nexo Luce SRL. The present datasheet and its content in whole or in part are the property of Nexo Luce SRL. All rights reserved. We reserve the right to change details and specifications without prior written notice.

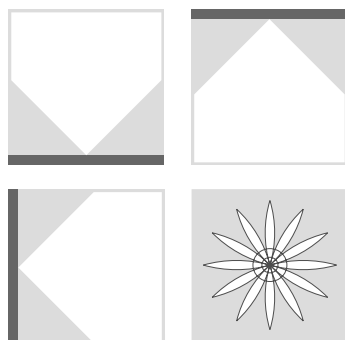

STAR EFFECT



*IP68 CONNECTORS ON REQUEST
*CONNETTORI IP68 SU RICHIESTA
code: 003.0223.0



*2x0.35 H05RN-F CABLE (1 meter) ON REQUEST
*CAVO 2X0.35 H05RN-F (1 metro) SU RICHIESTA
code: 003.0224.0

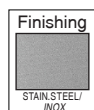

Finishing

STAIN STEEL / INOX

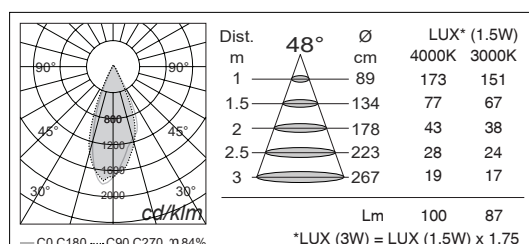
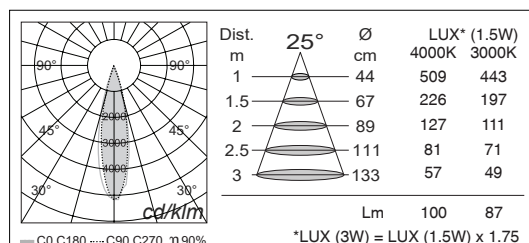
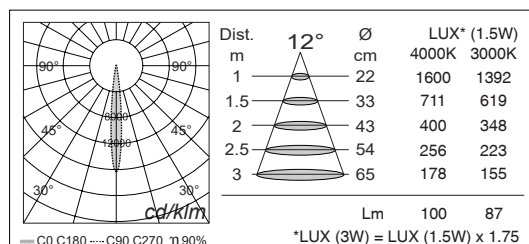
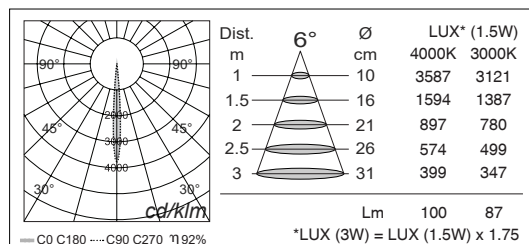

MAIN CODE CODICE BASE	RELEASE EDIZIONE	LIGHT COLOR COLORE LUCE	WATT WATT	OPTIC OTTICA	CONTROL CONTROLLO	FRAME COLOR COLORE
1000	.2	B 3000K	.01 1.5W	.A 6°	1 ON/OFF	.G STAIN. STEEL / INOX
		C 4000K	.03 3W	.C 12°		
		* others on request / altri su richiesta		.E 25°		
				.I 48°		
				AO STAR		

CODE EXAMPLE : Projector with warm white light color at 3000K, 1.5W, 12° optic, ON/OFF control, frame stainless steel color
1000.2B.01.C1.G

ESEMPIO DI CODIFICA : Proiettore con luce calda a 3000K, 1.5W, ottica 12°, controllo ON/OFF, colore in acciaio inox
1000.2B.01.C1.G

NEXO LUCE (Factory)
Strada Mirabella, 10
46040 Cavriana (MN), ITALY
T +39 0376 771513 F +39 0376 772235
sales@nexoluce.com www.nexoluce.com

Made in Italy