

BRASS & SPOTS VE 1065 A2

Design by: Studio Stile Masiero



Base in fusione d'ottone dorata, paralume in Shantung Avorio.

Gold plated solid brass base, Ivory Shantung lampshade.

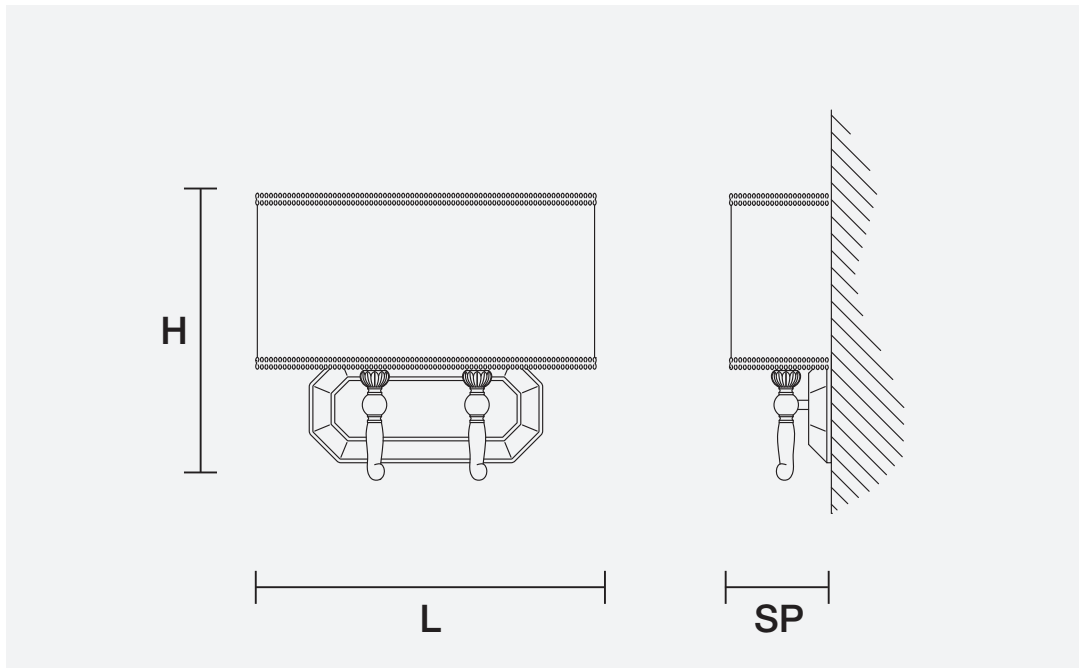

H	28 cm 11.02"
L	37 cm 14.56"
SP	11 cm 4.33"

 2 x E14 x 40W max
Incandescenza/Incandescent

MATERIALI MATERIALS

CUT CRYSTAL

Pendagli in cristallo trasparente molato.

Pendants in transparent cut crystal.

SWAROVSKI® ELEMENTS

Pendagli in cristallo trasparente SWAROVSKI® ELEMENTS.

Pendants in transparent SWAROVSKI® ELEMENTS crystal.

HALF CUT GLASS

Pendagli in vetro semi-molato.

Half cut glass pendants.

