

technics

Lamp not included.
Only LED lamp allowed, no halogen!

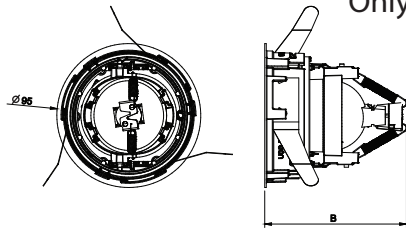

Name	Reference	Voltage ⚡	B (Soora lamp added)	Max wattage
Directional aplis 80 LED MR16	KR93780x	12V	97	15 W
Directional aplis 80 LED par16	KR93784x	240V	117	15 W
Fixed aplis 80 LED MR16	KR93723x	12V	97	15 W
Fixed aplis 80 LED par16	KR93725x	240V	117	15 W

The luminaire must not under any circumstances be covered with heat insulating covers or similar materials.
Cables must not touch the luminaire housing.
The connection cable must be routed so that it does not touch the lamp when the luminaire is tilted.

1 dimensions

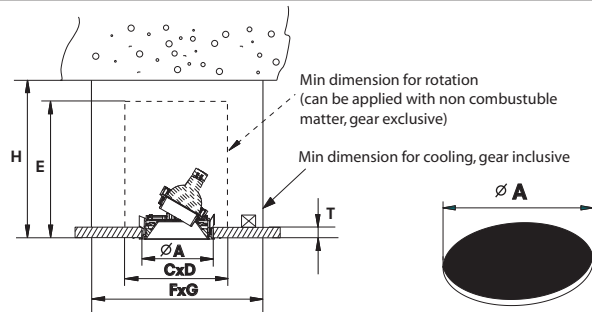

Name	Reference	A	CxD	E _{min}	FxG	H _{min}	T _{min} -T _{max}
Directional aplis 80 LED MR16	KR93780x	90	191x191	110	350x350	110	
Directional aplis 80 LED par16	KR93784x	90	176x176	130	330x330	130	
Fixed aplis 80 LED MR16	KR93723x	90	191x191	110	350x350	110	
Fixed aplis 80 LED par16	KR93725x	90	176x176	130	330x330	130	

Plasterboard thickness

9-26

2 cut out

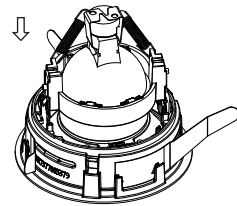

Please make sure that main voltage is disconnected before proceeding! ⚡

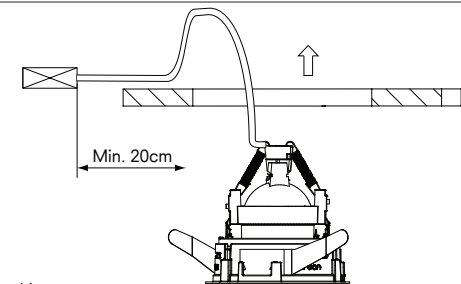

In case of transformer or driver.

3 installation

Insert lamp into socket with springs.

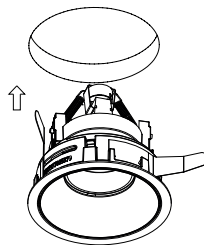

In case of directional part.

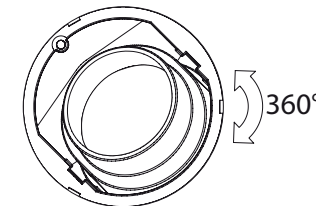
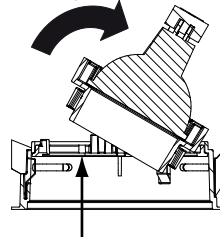

Turn inner part manually.

4 installation

Fold the springs against the ring and rotate anti clockwise to insert into the ceiling.

Push at the filterholder to rotate inner part manually.

technics

In case of relamping

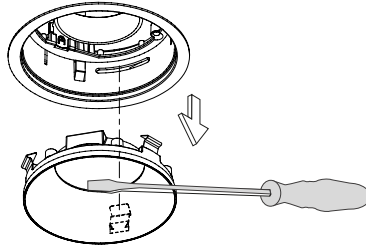

Remove the louvre (use tool in case of fixed).

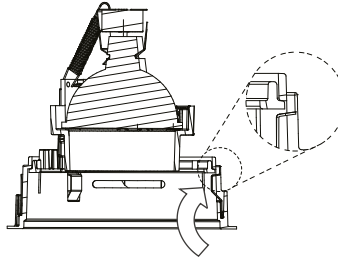

Bend springs to remove directional part

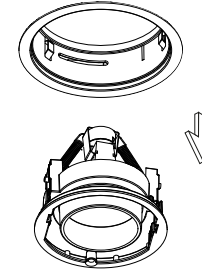

Remove inner part.

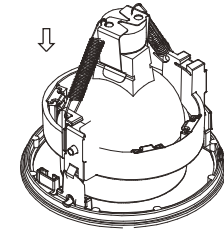

Replace lamp.

5 dimensions

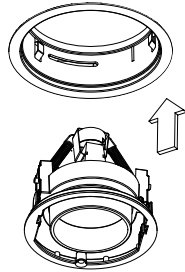

Add inner part.

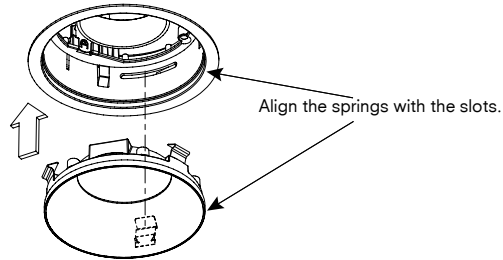

Insert the louvre in the ring.

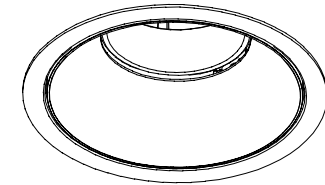

6 installation

