

KIMONO suspension

Matteo Ugolini design

year 2012

TECHNICAL SHEET - SE635V-EXT

STRUCTURE "A"

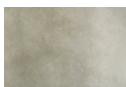
material	fiberglass	
colour	white	

ELECTRICAL CABLE "C"

material	neoprene	
colour	green	

SUSPENSION CABLE "F"

material	steel
----------	-------

ELECTRICAL SYSTEM

socket	E27
source	max 1x23w
energy class	from E to A++





PACKAGING

nr. of collis	1
net weight/kg	5
gross weight/kg	8,2
packaging/cm	63x63x67

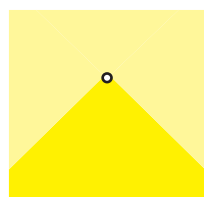
EMISSION OF LIGHT

one-directional



	direct
	filtered
	indirect
	none

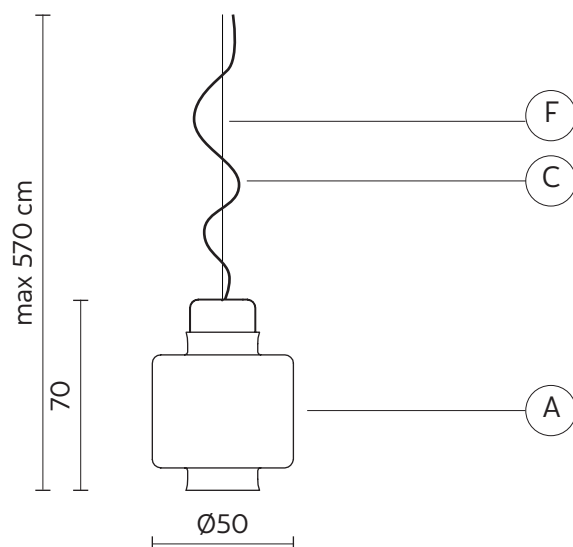

CERTIFICATION

IEC	60598-1:2008
EN	60598-1:2008 + A11:2009



IP rate	IP65
bulb	not provided

COLLECTION

