

# SETTENANI COLLECTION "FOLO" suspension

Matteo Ugolini design

year 2014

## TECHNICAL SHEET - SE681N1

### STRUCTURE "A"

|          |         |   |
|----------|---------|---|
| material | ceramic |  |
| colour   | white   |   |

### CEILING CUP "E"

|          |           |
|----------|-----------|
| material | metal     |
| colour   | matt grey |

### ELECTRICAL CABLE "C"

|          |             |   |
|----------|-------------|---|
| material | PVC         |  |
| colour   | transparent |   |

### ELECTRICAL SYSTEM

|              |               |
|--------------|---------------|
| socket       | E27           |
| source       | max 1x70w     |
| energy class | from E to A++ |





### PACKAGING

|                 |          |
|-----------------|----------|
| nr. of collis   | 1        |
| net weight/kg   | 4,15     |
| gross weight/kg | 5,4      |
| packaging/cm    | 35x35x38 |

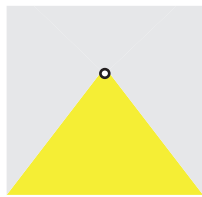
### EMISSION OF LIGHT

one-directional



|   |          |
|---|----------|
|  | direct   |
|  | filtered |
|  | indirect |
|  | none     |

### CERTIFICATION

|     |                         |
|-----|-------------------------|
| IEC | 60598-1:2008            |
| EN  | 60598-1:2008 + A11:2009 |



|         |              |
|---------|--------------|
| IP rate | IP20         |
| bulb    | not provided |

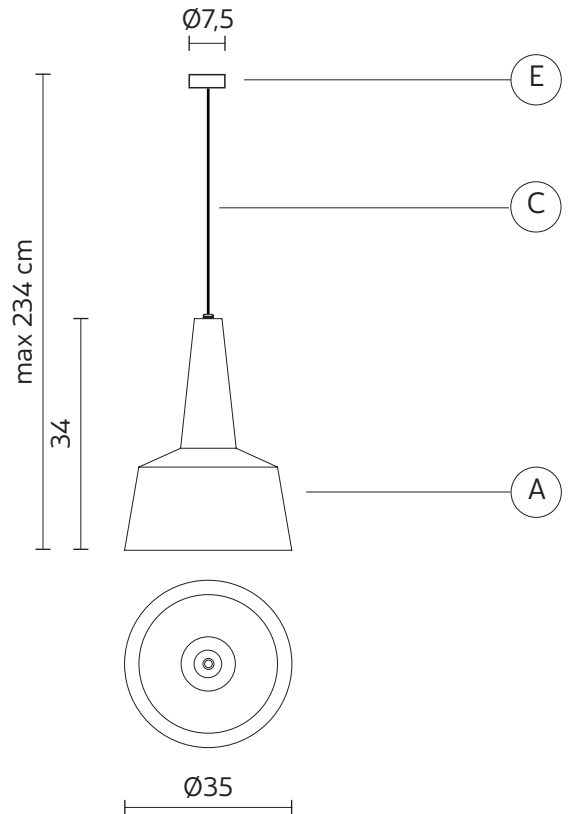

### COLLECTION

available also as: table lamp and floor lamp

