

technics

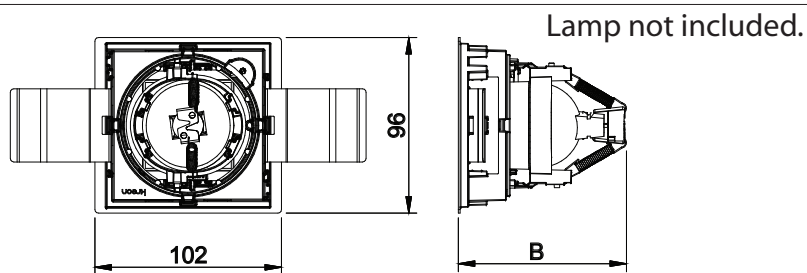

Name	Reference	Voltage ⚡	B (lamp added)	Max wattage
Down 80 directional led mr16	KR94780x	12V	97	15W
Down 80 directional led par16	KR94784x	230V	117	15W
Down 80 fixed led mr16	KR94723x	12V	97	15W
Down 80 fixed led par16	KR94725x	230V	117	15W

The luminaire must not under any circumstances be covered with heat insulating covers or similar materials.
Cables must not touch the luminaire housing.
The connection cable must be routed so that it does not touch the lamp when the luminaire is tilted.

1 dimensions

Only LED lamp allowed, no halogen!

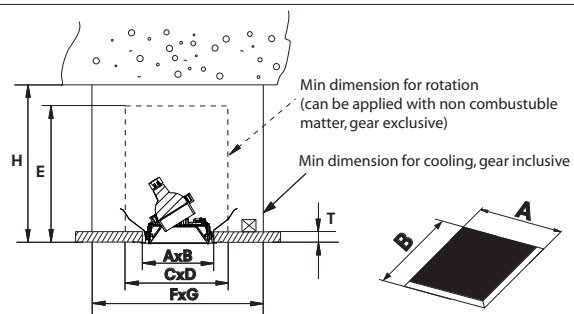

Name	Reference	A x B	CxD	E _{min}	FxG	H _{min}	T _{min} -T _{max}
Down 80 directional led mr16	KR94780x	91x91	230x230	110	350x350	110	
Down 80 directional led par16	KR94784x	91x91	230x230	130	330x330	130	
Down 80 fixed led mr16	KR94723x	91x91	230x230	110	350x350	110	
Down 80 fixed led par16	KR94725x	91x91	230x230	130	330x330	130	

Plasterboard thickness

9-26

2 cut out

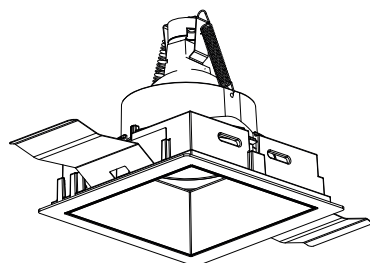

Insert lamp into socket with springs.

Please make sure that main voltage is disconnected before proceeding! ⚡

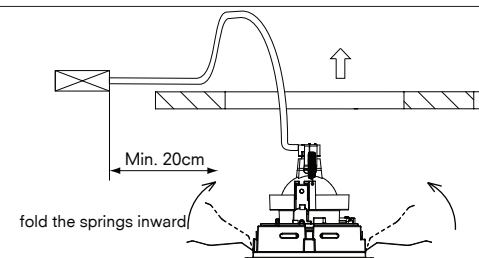

In case of transformer or driver.

3 installation

In case of directional part

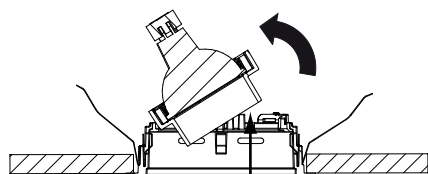

Push at the filterholder to rotate inner part manually.

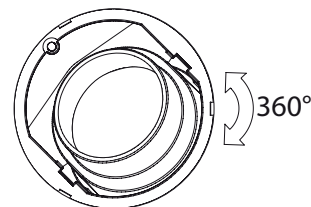

Turn inner part manually.

In case of relamping

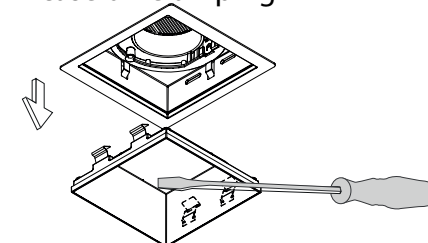

Remove the louvre (use tool in case of fixed).

4 installation

technics

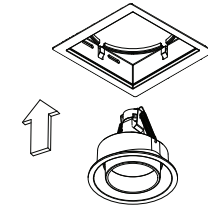
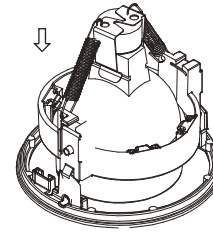
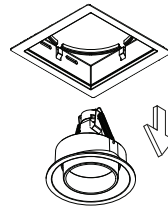
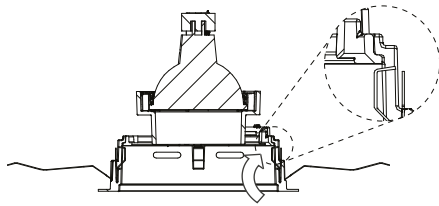

5 dimensions

Bend springs to remove directional part

Remove inner part.

Replace lamp.

Add inner part.

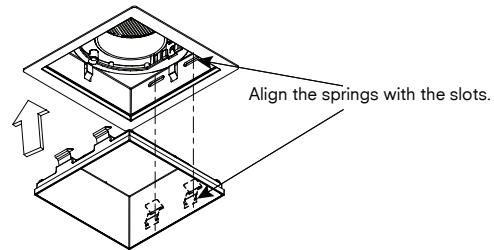

6 installation

Insert the louvre in the plasterkitbox.

