

Name: Garota - S / 02

Design: Alex Fernández Camps / Gonzalo Milà / 2015

Typology: Outdoor pendant lamp







Environment: Outdoor

Technical description:

Large outdoor pendant lamp with frame and canopy made of aluminum that can withstand exposure to the elements. Lamp shade is composed of hand wrapped polyethylene synthetic fiber, available in different colors. Light source is protected by a frosted, polyethylene globe of medium density and UV protection. Electrical cord is protected with water-proof neoprene coating. Available in Brown or Ivory finishes. Garota is not a customizable product.



Lamps description

 Grounding: compulsory
 2 x 20 W E26 Triple CFL
 2 x 10 W E26 A19 LED
Voltage: 120V~60Hz
 1 Box 31.50 x 31.50 x 19.69 inches
Vol.: 11.3007 ft ³ Weight: 20.55 lbs
Certifications:   IP-55
 Photometrics made according to the position the lights are shown in the catalogue and price list.

Ref Finishings

3350220201U	Natural White
3350220203U	Brown Graphite
P-801	Ivory White
P-802	Brown
All Bover's synthetic fiber collection are recyclable and non-toxic for environmental sustainability.	
Aluminium shade frame and canopy	
Dry + wet location	
Not Customizable	

Measures

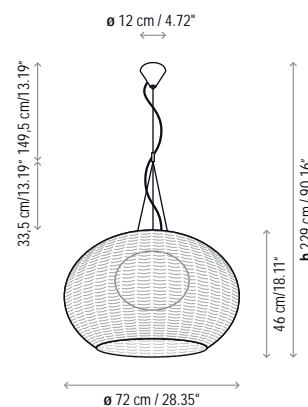

Garota - A / 01

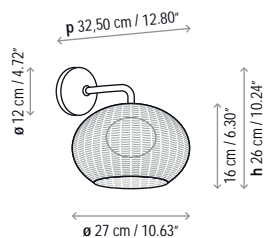

Garota - PF / 01

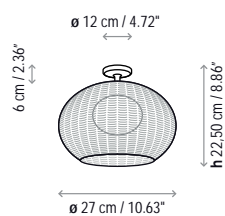

Garota - PF / 02

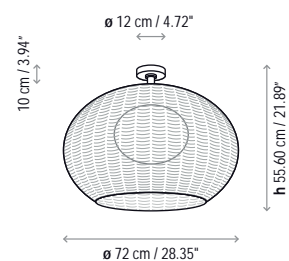

Garota - Hang

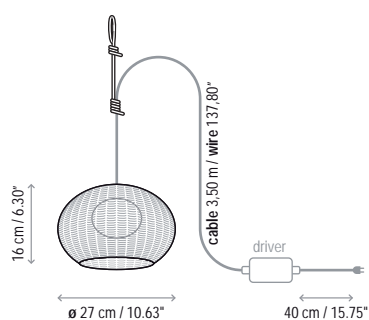

Garota - S / 01

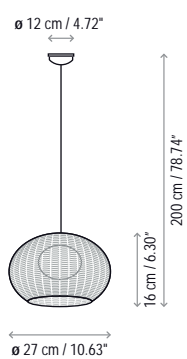

Garota - S / 02

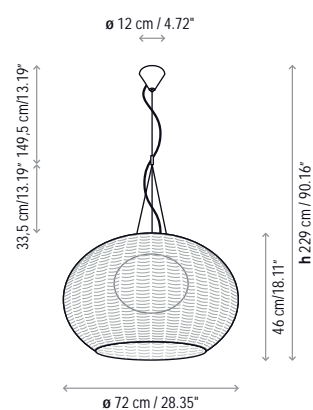

Garota - Mini

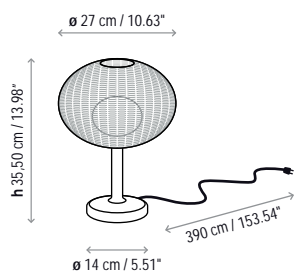

Garota - P / 01

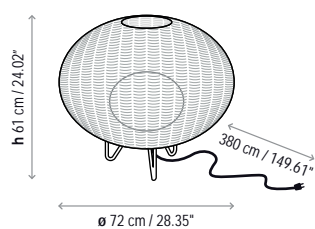

Garota - P / 02

