

FLY floor lamp

Matteo Ugolini design

year 2009

TECHNICAL SHEET - H6024DB

STRUCTURE "A" - BASE "D"

material	aluminum	
colour	silver	

SHADE "B"

material	linen	
colour	white	

ELECTRICAL CABLE "C"

material	PVC	
colour	transparent	

ELECTRICAL SYSTEM

socket	E27
source	max 1x105w
energy class	from E to A++





PACKAGING

nr. of collis	3
net weight/kg	19
gross weight/kg	25,5
packaging/cm	38x12x122(A) - 52x52x40(B) 58x58x6(D)

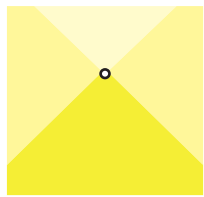
EMISSION OF LIGHT

one-directional



	direct
	filtered
	indirect
	none

CERTIFICATION

IEC	60598-1:2008
EN	60598-1:2008 + A11:2009



IP rate	IP20
bulb	not provided

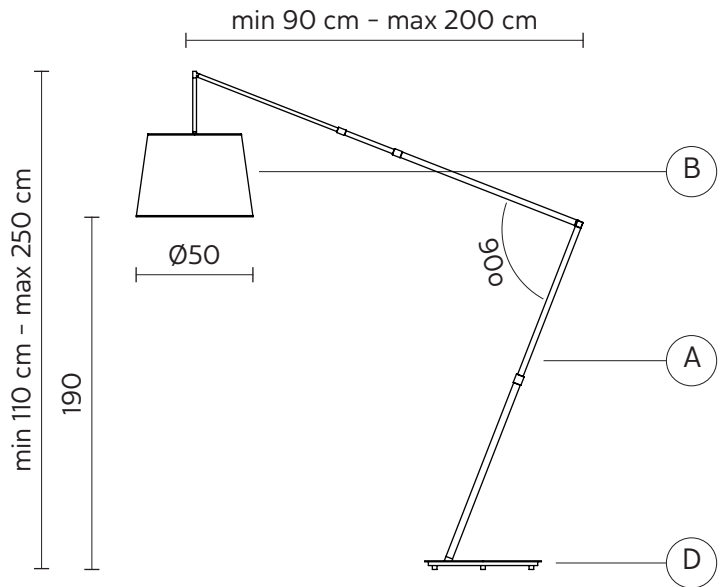

COLLECTION

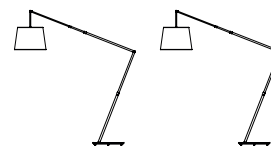

H6024NN H6024BB