

# Mikado

Massimiliano Raggi



AP

AP SOLO

TA

FL

SO

SO DOUBLE



Collezione di lampade "gioiello" caratterizzate dall'abbinamento di tubi rettangolari in ottone e di cubi obliqui in cristallo inciso, con due tipi di lavorazione. Le combinazioni apparentemente casuali (da qui il nome Mikado) seguono invece uno schema preciso ed equilibrato. Le sorgenti a Led, inserite nei tubi in modo tale da mettere in risalto la preziosità del cristallo, rendono Mikado un prodotto decorativo altamente performante e compatibile con i sistemi di domotica.

*A collection of "jewel" lamps characterised by the combination of rectangular brass tubes and slanted cubes in engraved crystal, with two types of workmanship. The apparently random juxtaposition (hence the name "Mikado") in fact follow a precise and balanced scheme. The LED sources, inserted in the tubes so as to showcase the preciousness of the crystal, make Mikado a high-performance decorative product that is compatible with home automation systems.*

## SPECIFICHE PRODOTTO / PRODUCT SPECIFICS

MIKADO AP  
MIKADO AP SOLO/2

MIKADO TA  
MIKADO FL

MIKADO SO  
MIKADO SO DOUBLE

p.2

p.4  
p.5

p.6  
p.7

p.8  
p.9

## STRUTTURA / *FRAME*



Ottone satinato  
*Satin brass*

## DIFFUSORE / *DIFFUSER*



Cristallo trasparente inciso  
*Engraved crystal*



Cristallo trasparente prismatic  
*Prismatic crystal*

## MANUTENZIONE E PULIZIA

### CRISTALLI

I cristalli usati nella famiglia Mikado sono realizzati con il 24% in peso di ossido di piombo, un cristallo purissimo che acquista il suo vero valore nel momento in cui i maestri vetrai, ad una temperatura della materia di 1150 gradi, ne traggono oggetti sempre unici, nella loro bellezza e qualità.

**Istruzioni per la manutenzione:** non utilizzare prodotti abrasivi, né solventi, né alcool. Usare solo un panno morbido con acqua evitando eccessiva frizione.

## MAINTENANCE AND CLEANING

### CRYSTAL

The crystal glass used in Mikado family is made with lead oxide (24% by weight). This is a very pure crystal that acquires its true value when formed by the glass masters, at a material temperature of 1150°C – resulting in unique objects of great beauty and quality.

**Maintenance instructions:** do not use abrasive products, solvents, or alcohol. Use only a soft cloth with water, avoiding excessive friction.



**CAVO - INTERRUTTORE/ CABLE - SWITCH**

Tessuto nero  
Black fabric

**TA**

Dimmerabile a tre livelli di intensità  
su base (100% - 70% - 30%)

*Dimmable with three intensity levels  
(100% - 70% - 30%) on the base*

L: 2000 mm  
L: 78.7"

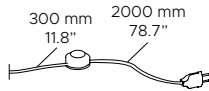
**FL**

Dimmerabile a piede

*Dimmable with foot control*

L: 300 + 2000 mm  
L: 11.8" + 78.7"

**FONTE LUMINOSA / LIGHT SOURCE****220-240V**

LED module

**AP**

4 x 4W  
LED module  
Emissione / Light emission: 2.240 Lm  
3.000 K; CRI: >90  
IP20

**AP SOLO/2**

2 x 4W  
LED module  
Emissione / Light emission: 1.120 Lm  
3.000 K; CRI: >90  
IP20

**TA**

6 x 4W  
LED module  
Emissione / Light emission: 3.360 Lm  
3.000 K; CRI: >90  
IP20

**FL / SO**

10 x 4W  
LED module  
Emissione / Light emission: 5.600 Lm  
3.000 K; CRI: >90  
IP20

**SO DOUBLE**

20 x 4W  
LED module  
Emissione / Light emission: 11.200 Lm  
3.000 K; CRI: >90  
IP20

**AP AP SOLO/2 / SO / SO DOUBLE**

Dimmerabile DALI/Push.  
Altri sistemi di dimmerazione  
disponibili su richiesta

*DALI/Push dimmable.  
Other dimming systems  
available on request*



Mikado FL e TA

**110V**

LED module

**AP**

4 x 4W  
LED module  
Light emission: 2.240 Lm  
3.000 K; CRI: >90  
IP20

**AP SOLO/2**

2 x 4W  
LED module  
Light emission: 1.120 Lm  
3.000 K; CRI: >90  
IP20

**TA**

6 x 4W  
LED module  
Light emission: 3.360 Lm  
3.000 K; CRI: >90  
IP20

**FL / SO**

10 x 4W  
LED module  
Light emission: 5.600 Lm  
3.000 K; CRI: >90  
IP20

**SO DOUBLE**

20 x 4W  
LED module  
Light emission: 11.200 Lm  
3.000 K; CRI: >90  
IP20

**AP AP SOLO/2 / SO / SO DOUBLE**

1...10V dimmable.  
Other dimming systems  
available on request



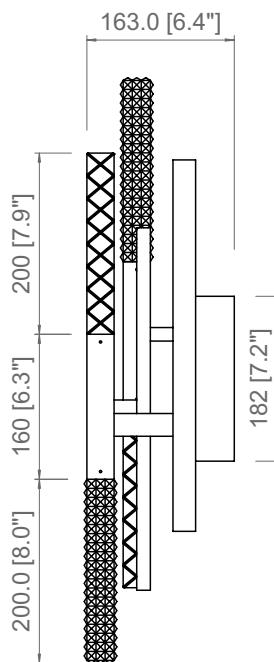
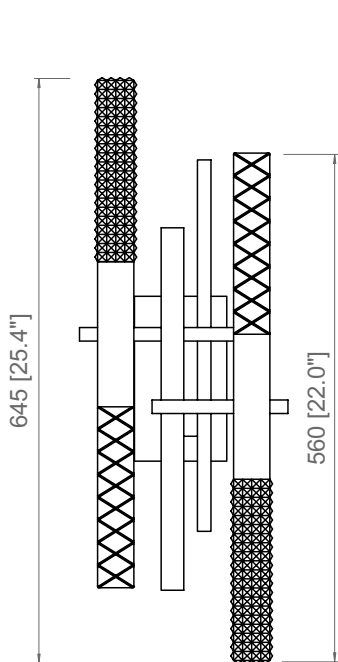
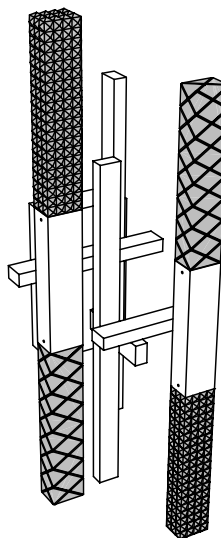
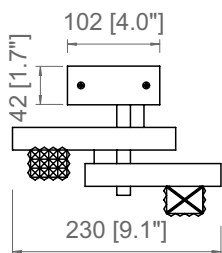

**PRODOTTO / PRODUCT    IMBALLI / PACKAGING**

**Peso-Weight**  
4 kg / 8.8 lbs

**Box 1**  
L: 520 mm / 20.4"  
P-W: 520 mm / 20.4"  
H: 320 mm / 12.6"  
Peso-Weight: 5 kg / 11 lbs

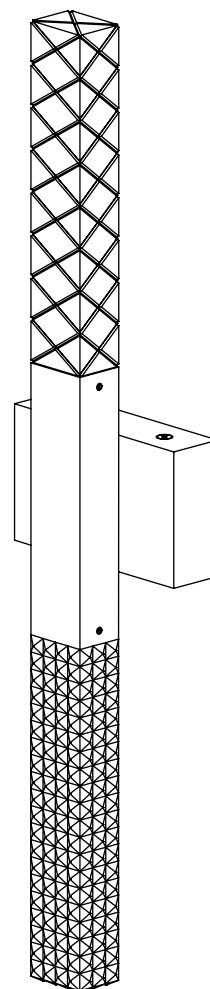
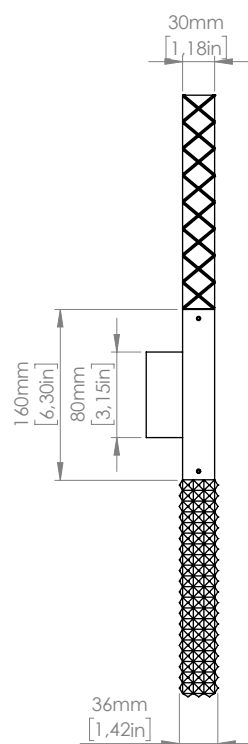
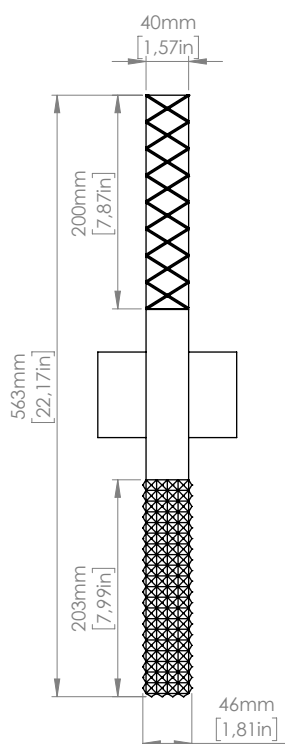
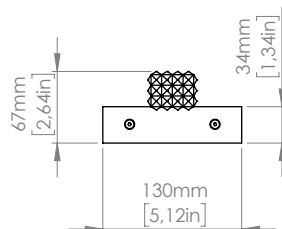

**PRODOTTO / PRODUCT IMBALLI / PACKAGING**

<b>Peso-Weight</b> 2 kg / 4.4 lbs	<b>Box 1</b> L: 320 mm / 12.6" P-W: 320 mm / 12.6" H: 130 mm / 5.1" Peso-Weight: 3 kg / 6.6 lbs
--------------------------------------	---

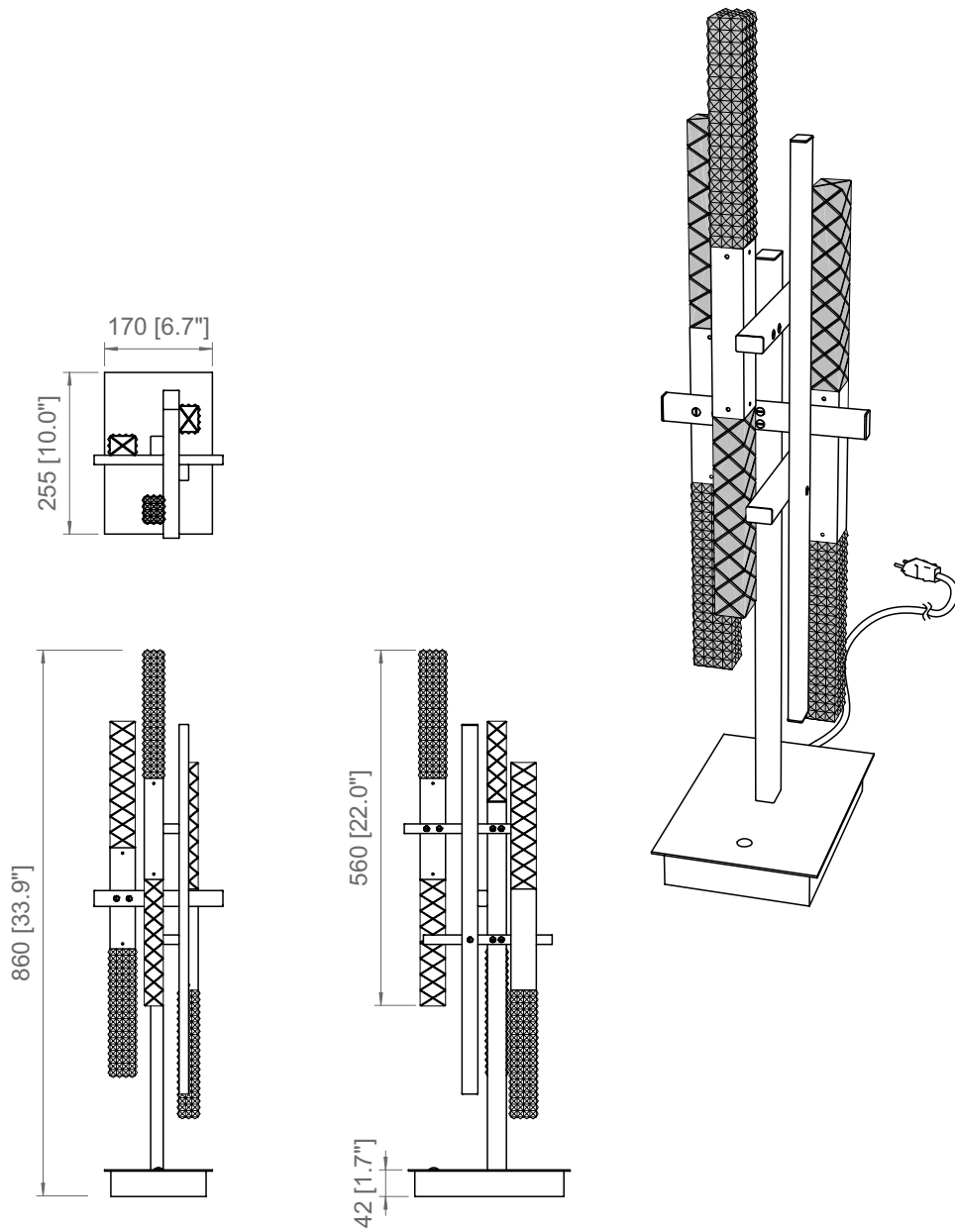

**PRODOTTO / PRODUCT    IMBALLI / PACKAGING**

**Peso-Weight**  
11 kg / 24.2 lbs

**Box 1**  
L: 360 mm / 14.2"  
P-W: 360 mm / 14.2"  
H: 890 mm / 35"  
Peso-Weight: 12 kg / 26.5 lbs

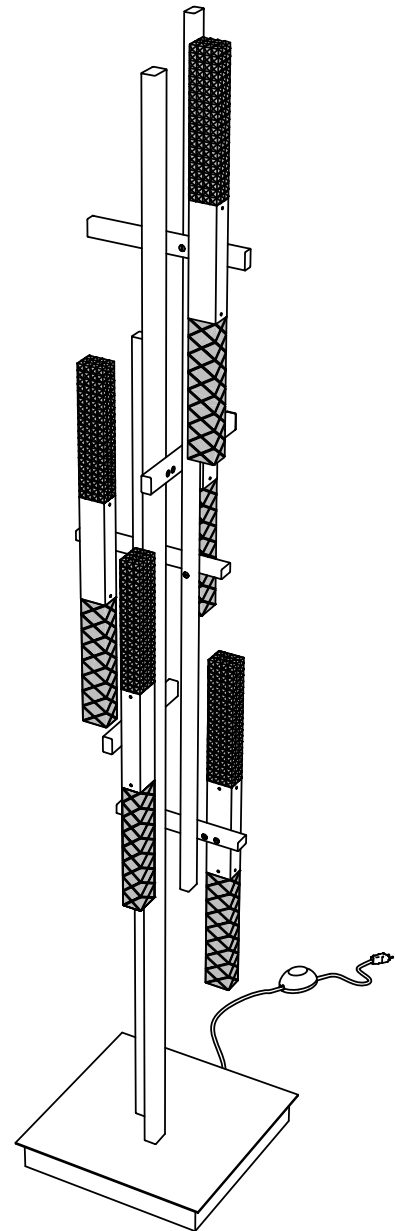
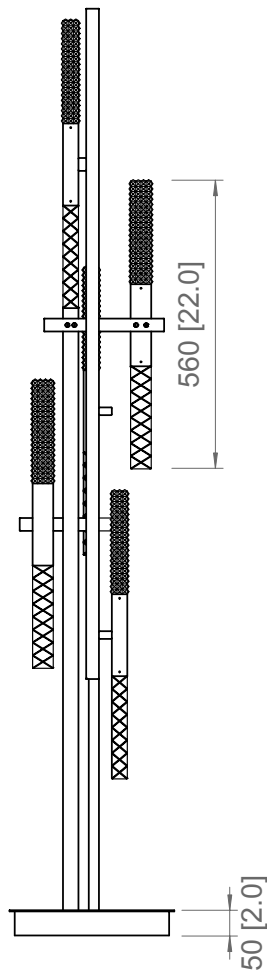
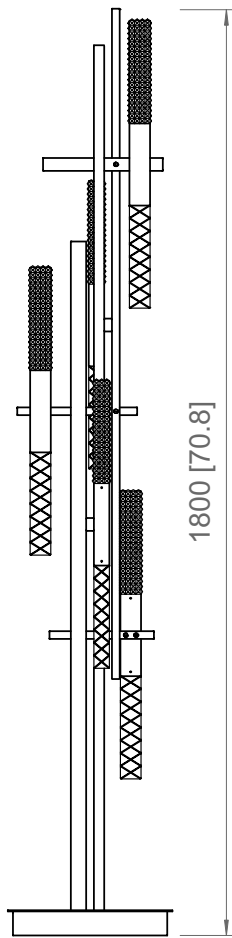
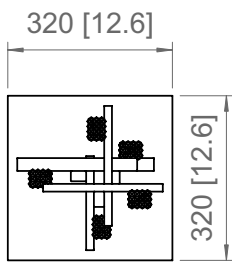

**PRODOTTO / PRODUCT    IMBALLI / PACKAGING**

**Peso-Weight**

23 kg / 50.7 lbs

**Box 1**

L: 450 mm / 17.7"

P-W: 450 mm / 17.7"

H: 1920 mm / 75.6"

Peso-Weight: 25 kg / 55.1 lbs

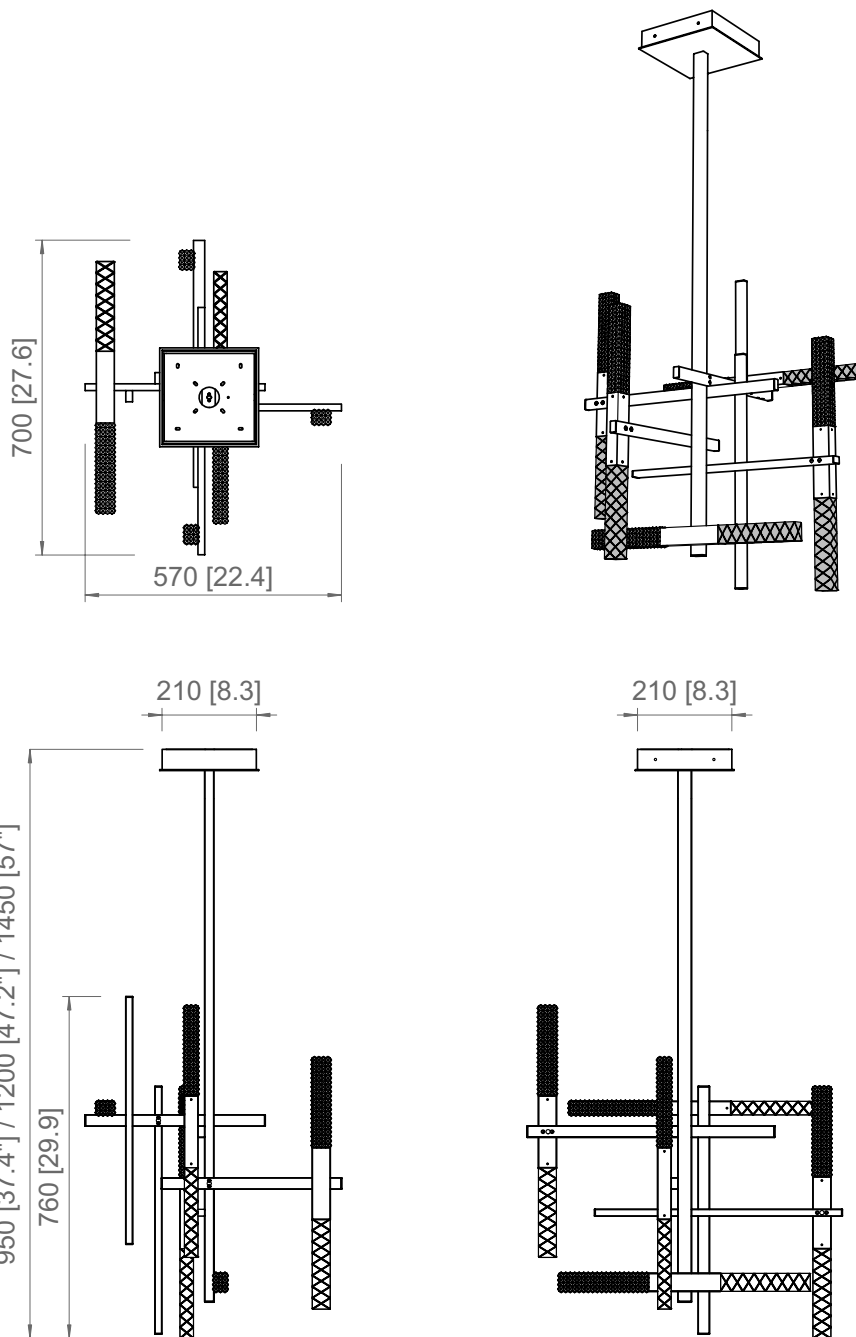

**PRODOTTO / PRODUCT IMBALLI / PACKAGING**

Peso-Weight	Box 1	Box 2
14 kg / 30.9 lbs	L: 810 mm / 31.9"	L: 430 mm / 17"
	P-W: 670 mm / 26.3"	P-W: 430 mm / 17"
	H: 1020 mm / 40.2"	H: 170 mm / 6.7"
	Peso-Weight: 12 kg / 26.4 lbs	Peso-Weight: 4 kg / 8.8 lbs



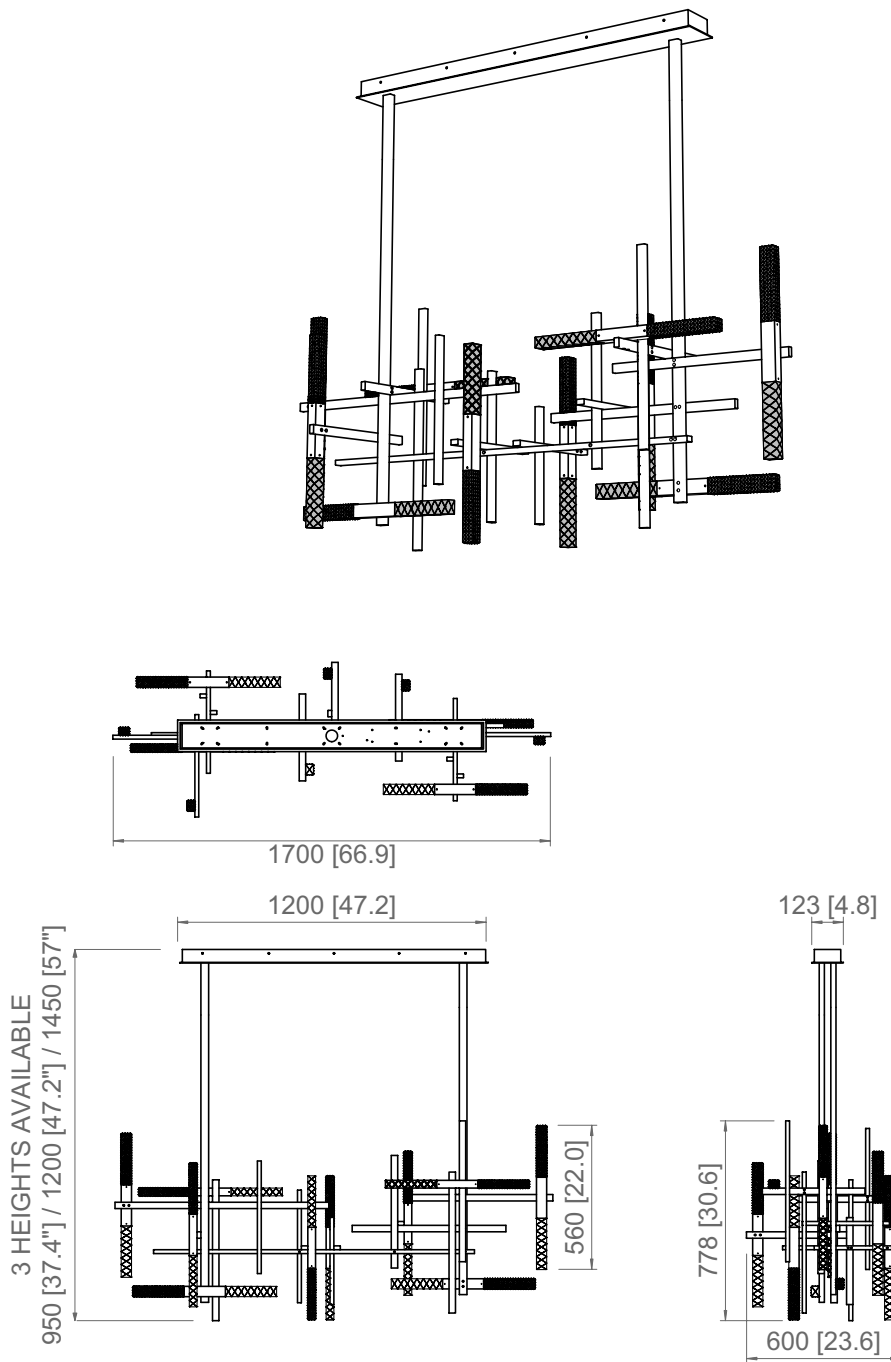

PRODOTTO / PRODUCT IMBALLI / PACKAGING

Peso-Weight	Box 1	Box 2
39 kg / 86 lbs	L: 1800 mm / 70.9" P-W: 720 mm / 28.3" H: 1500 mm / 59" Peso-Weight: 36 kg / 79.4 lbs	L: 520 mm / 24.5" P-W: 520 mm / 24.5" H: 320 mm / 12.6" Peso-Weight: 8.5 kg / 18.7 lbs

Copyright and/or design rights subsist in this drawing. No part of this drawing may be reproduced in any material form (including photocopying or storing in any medium electronic means, whether or not intentionally and whether or not as part or a larger publication) without the express permission of the copyright owner, Contardi Lighting S.r.l.. Further and without prejudice to the above, this drawing and all information relating thereto is confidential, and shall not be communicated to a third party without the consent of Contardi lighting srl. Contardi lighting srl asserts all rights to be identified as the author of the work and otherwise.

WARNING: The doing of any unauthorised act in relation to a copyright work may result in both a civil claim for damages and criminal prosecution.

---

**CONTARDI LIGHTING Srl**

ITALY HEADQUARTERS

[www.contardi-italia.com](http://www.contardi-italia.com) / [sales@contardi-italia.it](mailto:sales@contardi-italia.it)

**CONTARDI USA Inc**

USA BRANCH

[www.contardi-usa.com](http://www.contardi-usa.com) / [sales@contardi-usa.com](mailto:sales@contardi-usa.com)

