



Struttura in metallo ricoperto in vetro, pendagli in cristallo, illuminazione LED.

Metal frame covered with glass, crystal pendants, LED lighting system.

Metallstruktur mit transparentem Glas bedeckt, Kristall-Gehänge, LED Lichtsystem

Structure métallique recouverte de verre, pendentifs en cristal, éclairage LED

Металлический каркас, покрытый стеклом, подвесы из хрусталя, светодиодное освещение.



H 70 cm / 27.55"
 Ø 100 cm / 39.37"

LED x 96 W CRI>80
 3000 K - 10200 lm
Dimmable: PUSH*

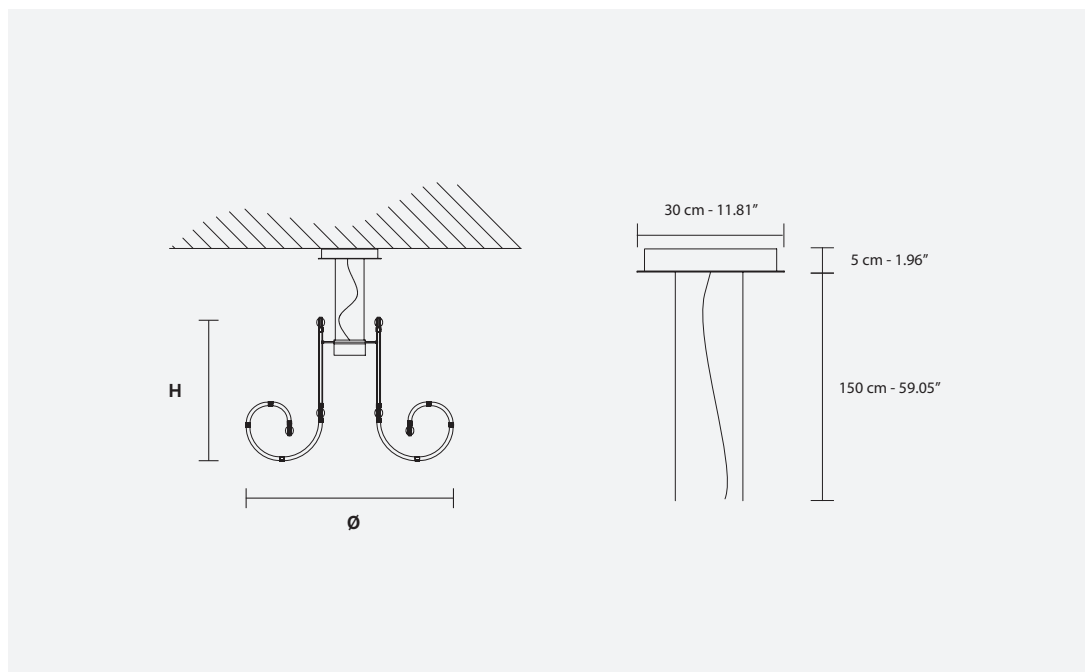

FRAME + GLASS

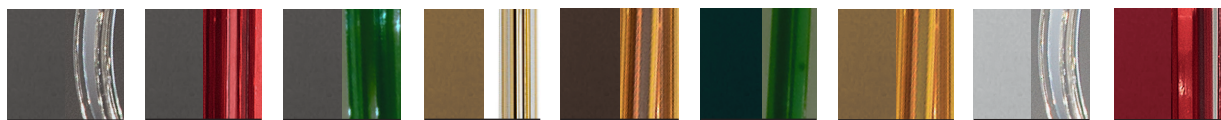

Chrome Transparent Chrome Red Chrome Green Gold Transparent Brown Orange Green Green Gold Orange White Transparent Red Red

PENDANTS

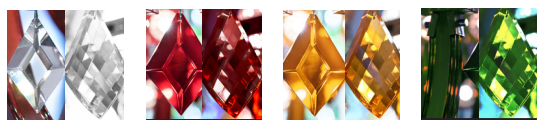

Transparent Red Orange Green

* "UL" logo refers to articles which can be modified with UL-compliant components. The "UL" listing mark stands for tested and evaluated product to recognized us safety standards.