

BLACK OUT floor lamp

Matteo Ugolini design

ООО "Мастерская светотехники"
8 800 100 39 72
8 495 727 14 91
9725087@masv.ru
http://masv.ru

year 2015

TECHNICAL SHEET - HP101 3B EXT

STRUCTURE "A"

material	metal	
colour	matt white	

SHADE "B"

material	fiberglass	
colour	white	

ELECTRICAL CABLE "C"

material	neoprene	
colour	green	

ELECTRICAL SYSTEM

socket	E27
source	max 1x28w
energy class	from E to A++





PACKAGING

nr. of collis	1
net weight/kg	5,5
gross weight/kg	8,8
packaging/cm	80x80x70

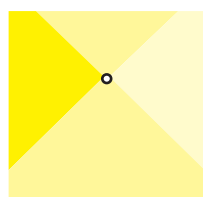
EMISSION OF LIGHT

one-directional



	direct
	filtered
	indirect
	none

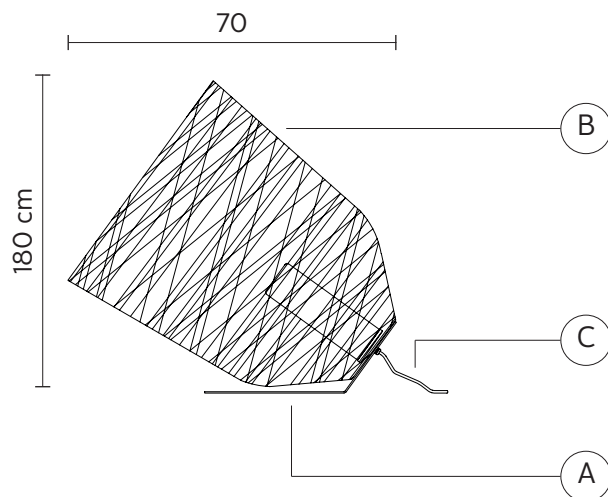

CERTIFICATION

IEC	60598-1:2008
EN	60598-1:2008 + A11:2009



IP rate	IP65
bulb	class A equipped

COLLECTION

available also as: suspension (in/outdoor)

