

BLACK OUT floor lamp

Matteo Ugolini design

ООО "Мастерская светотехники"
8 800 100 39 72
8 495 727 14 91
9725087@masv.ru
http://masv.ru

year 2015

TECHNICAL SHEET - HP101 3T INT

STRUCTURE "A"

| | | |
|----------|------------|---|
| material | metal |  |
| colour | matt white | |

SHADE "B"

| | | |
|----------|-------------|---|
| material | fiberglass |  |
| colour | transparent | |

ELECTRICAL CABLE "C"

| | | |
|----------|-------------|---|
| material | PVC |  |
| colour | transparent | |

ELECTRICAL SYSTEM

| | |
|--------------|---------------|
| socket | E27 |
| source | max 1x105w |
| energy class | from E to A++ |





PACKAGING

| | |
|-----------------|----------|
| nr. of collis | 1 |
| net weight/kg | 4,3 |
| gross weight/kg | 7,6 |
| packaging/cm | 80x80x70 |

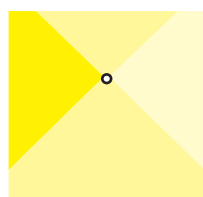
EMISSION OF LIGHT

one-directional



| | |
|---|----------|
|  | direct |
|  | filtered |
|  | indirect |
|  | none |

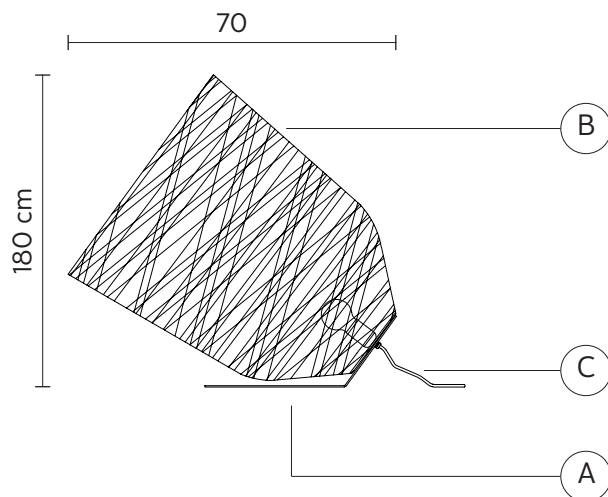

CERTIFICATION

| | |
|-----|-------------------------|
| IEC | 60598-1:2008 |
| EN | 60598-1:2008 + A11:2009 |



| | |
|---------|--------------|
| IP rate | IP20 |
| bulb | not provided |



code **700B**
decorative bulb
E27 - 25w - ≤ 60 lumen
class E

COLLECTION

available also as: suspension (in/outdoor)

