

boverinfo@boverusa.com
www.boverusa.com**Elea PF/85**

Name: Elea PF/85

Design: Joana Bover / 2013

Typology: Ceiling lamp

Environment: Indoor

Technical description:

Polyurethane, circular ceiling mount finished in brilliant lacquer with optical glass lower diffuser. Available in two ceiling sizes, and also as a pendant fixture. Direct wire electrical connection. Elea is not a customizable product. For special finishings the RAL number is needed, and the minimum quantity is 3 units.



Lamps description

 Grounding: compulsory

 4 x 55 W 2G11 Twin CFL

Voltage: 120-277 V / 50-60 Hz

 1 Box 35.43 x 35.43 x 9.84 inches
Vol.: 7.1512 ft³

Weight: 55.12 lbs

Certifications:  
 Photometrics made according to the position the lights are shown in the catalogue and price list.

Ref Finishings

510332401U White Brilliant Lacquer

510332423U Black Brilliant Lacquer

510332422U Red Brilliant Lacquer

D510332401U* DIM 0-10V
White Brilliant LacquerD510332423U* DIM 0-10V
Black Brilliant LacquerD510332422U* DIM 0-10V
Red Brilliant Lacquer

*Dimming ballast (DIM 0-10V)

Finishing: Brilliant lacquer finish

Material: Polyurethane

Optical glass diffuser

Not Customizable

Measures

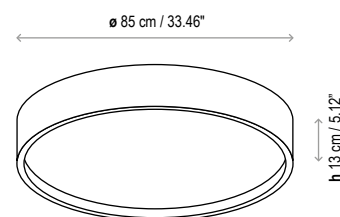

Elea PF/55

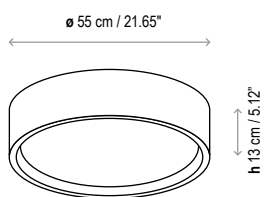

Elea PF/85

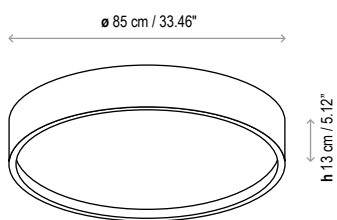

Elea S/55

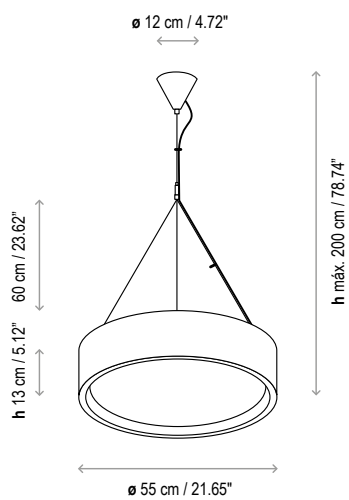

Elea S/85

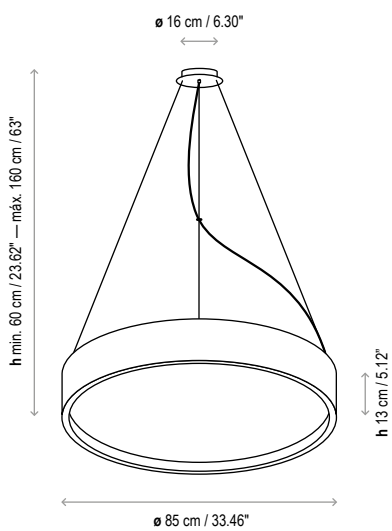

Elea S/95

