

boverinfo@boverusa.com
www.boverusa.com

Fora A/01 Outdoor

Name: Fora A/01 Outdoor

Design: Alex Fernández Camps / Gonzalo Milà / 2010

Typology: Wall lamp

Environment: Outdoor

Technical description:

Outdoor wall lamp releasing light through a frosted medium density, UV protected polyethylene globe, shielded by weaved synthetic polyethylene fiber lamp shade. Lamp shade is available in natural white and brown graphite. Canopy is aluminum, coated with anti-corrosive, cataphoresis treatment to provide comprehensive protection against all weather conditions in accordance with IP 55 rating. Electrical cord is encased with protective neoprene. (IP 55).

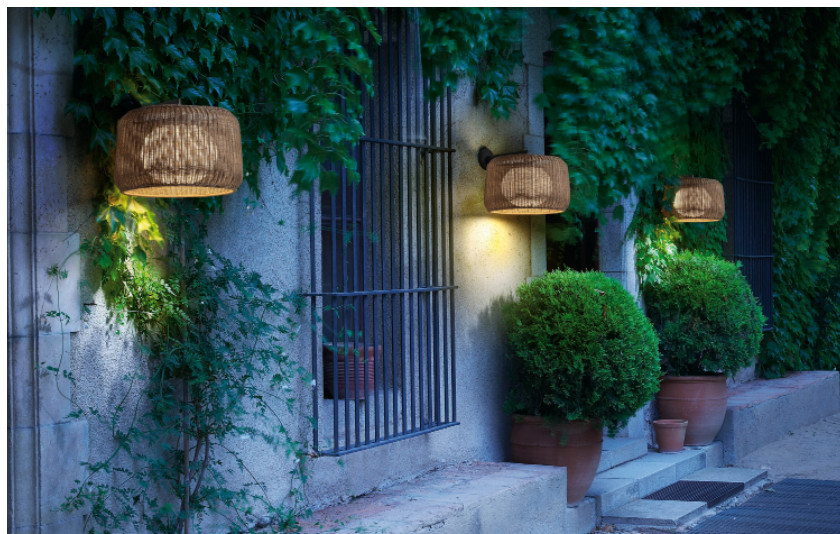

Lamps description

 Grounding: compulsory

 2 x 20 W E26 Triple CFL

 2 x 10 W E26 A19 LED

Voltage: 120V~60Hz

 1 Box 23.62 x 23.62 x 19.69 inches

Vol.: 6.3566 ft³

Weight: 15.43 lbs

Certifications:   **IP-55**

 Photometrics made according to the position the lights are shown in the catalogue and price list.

Ref Finishings

SETS:

1130301U Natural White

P-695C Light Beige

1130303U Brown Graphite

P-696C Brown

All Bover's synthetic fiber collection are recyclable and non-toxic for environmental sustainability.

Lampshade 19.69" x 11.81"
Synthetic Polyethylene Fiber,
aluminum frame.
(Operating temperature: -70°C to +70°C)

Light source is protected by polyethylene globe of medium density and UV protection.
(Operating temperature: -40°C to +70°C)

Not stock item - made to order

Not Customizable

Measures

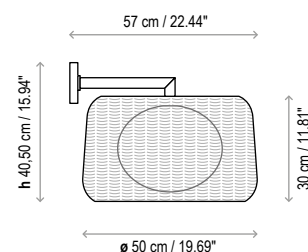

Fora A/01 Outdoor

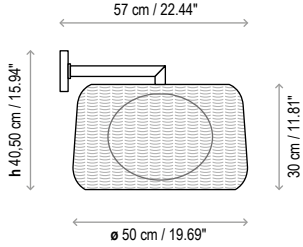

Fora PF/50 Outdoor

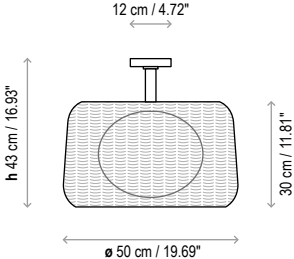

Fora S/50 Outdoor

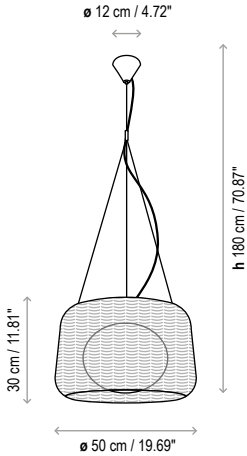

Fora S/90 Outdoor

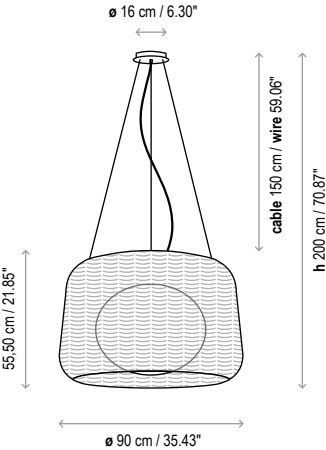

Fora M/70 Outdoor

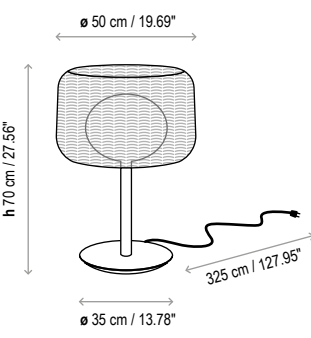

Fora P/165 Outdoor(Concrete Base)

