

boverinfo@boverusa.com
www.boverusa.com**Basik 02**

Name: Basik 02

Design: Joana Bover / 2010

Typology: Wall lamp

Environment: Indoor





Technical description:

Wall light with brass structure coated in satin nickel or brilliant chrome. Various lamp shade options: double mesh lamp shade, offering inner shade options of black or red mesh mounted on a rigid fire-resistant white polyester screen, and outer shade options in black or red mesh mounted on PVC fiber screens. Single lamp shades are also available in classic white cotton, or white and cream translucent polyester blend hand wrapped ribbon.

Swivel arm allows for swift, easy adjustment.



Lamps description

	Grounding: compulsory
	1 x 60 W E26 A15 INC
	1 x 5 W E26 A15 LED
	1 x 13 W GU24 T2 CFL
	1 x 10 W GU24 A15 LED

Voltage: 120V~60Hz

 1 Box 17.72 x 17.72 x 13.78 inches
Vol.: 2.5038 ft³

Weight: 4.41 lbs

Certifications:  
 Photometrics made according to the position the lights are shown in the catalogue and price list.

Ref	Finishings
1132105U	Satin Nickel
1132106U	Brilliant Chrome
1132105GU	Satin Nickel / GU24
1132106GU	Brilliant Chrome / GU24
Outer lampshade 8.66" x 6.30" x 7.09"	
P-633E	White Cotton
Cotton Shade Without Upper Diffuser	
P-634E	White Translucent Ribbon
P-635E	Cream Translucent Ribbon
Set of double lamp shades:	
P-636E*	Black Mesh
P-636I**	Black Mesh
P-637E*	Red Mesh
P-637I**	Redmesh
* Outer lampshade: PVC crystal	
** Inner lampshade	
Inner shade made of a fireresistent polyester rigid film	
Swivel arm / brass-raw material	
Surface back box: 6.69" x 3.15"	
No switch included	

Measures

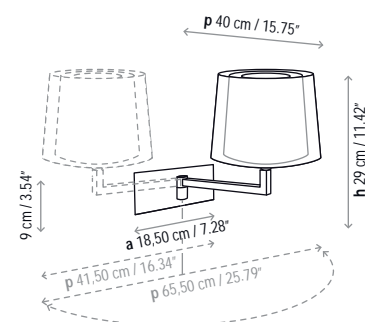

Customizable

IMPORTANT NOTE:
Must mount horizontally on 2" x 4" rectangular junction box.