

Name: Urban PF/37

Design: Joana Bover / 2011

Typology: Ceiling lamp









Environment: Indoor

Technical description:

Ceiling lamp with frame, coated in brilliant chrome and hand wrapped with translucent, polyester blend ribbon in cream, white or red. Glass, opaque diffuser is included with fixture. Available in larger format.



Lamps description

	Grounding: compulsory
	2 x 60 W E26 A15 INC
	2 x 5 W E26 A15 LED
	2 x 14 W E26 Triple CFL
Voltage: 120V~60Hz	
	1 Box 15.75 x 15.75 x 9.84 inches
Vol.: 1.4126 ft ³	
Weight: 8.82 lbs	
Certifications:  	
	Photometrics made according to the position the lights are shown in the catalogue and price list.

Ref	Finishings
0132506BU	Chrome White Translucent Ribbon
0132506CU	Chrome Cream Translucent Ribbon
0132506RU	Chrome Red Translucent Ribbon
Customizable	

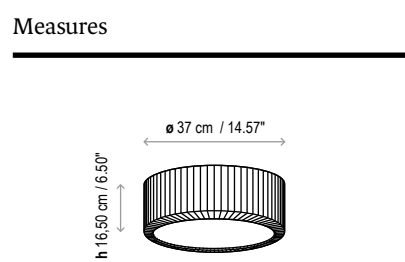

Urban PF/37

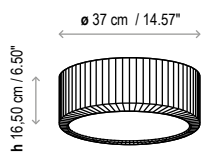

Urban PF/60

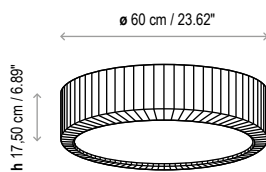

Urban PF/90

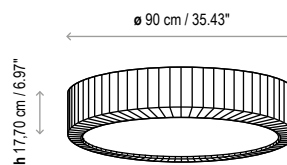

Urban PF/120

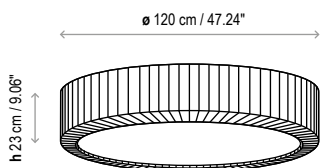

Urban S/37

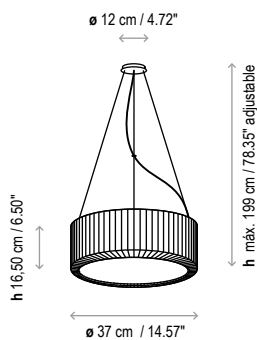

Urban S/60

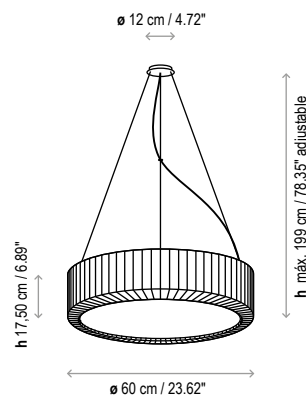

Urban S/90

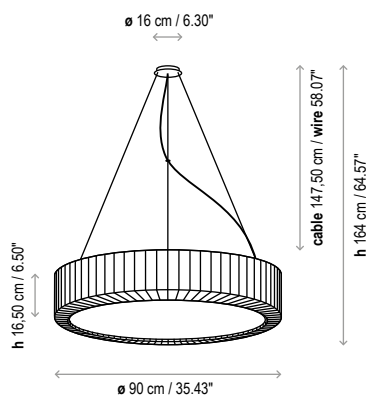

Urban S/120

