

IMPERO-DECO VE 1182 A1

Design by: Studio Stile Masiero



Paralume damascato con pendagli in cristallo.

Damask lampshade with crystal pendants.

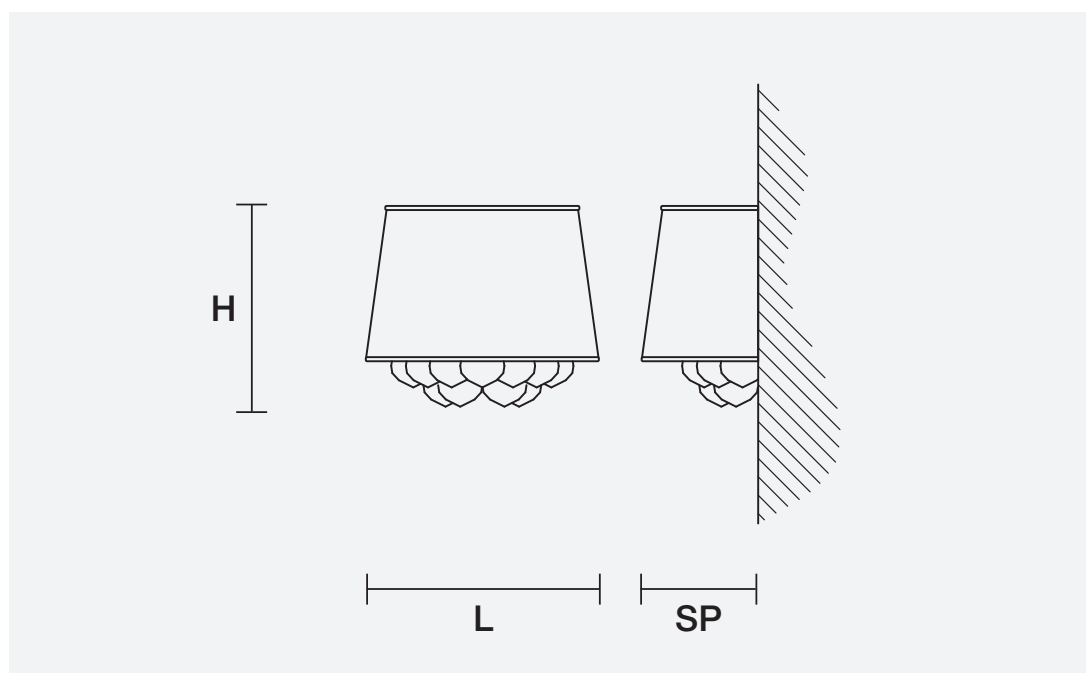

H	22 cm 8.66"
L	29 cm 11.41"
SP	16 cm 6.29"

 1 x G9 x 40W max
Alogena/Halogen



MATERIALI MATERIALS

CUT CRYSTAL

Pendagli in cristallo trasparente molato.

Pendants in transparent cut crystal.

SWAROVSKI® ELEMENTS

Pendagli in cristallo trasparente SWAROVSKI® ELEMENTS.

Pendants in transparent SWAROVSKI® ELEMENTS crystal.

HALF CUT GLASS

Pendagli in vetro semi-molato.

Half cut glass pendants.