

ideal lux®

IDEAL LUX s.r.l.
Via Taglio Destro 32
30035 Mirano (VE) Italy
www.ideal-lux.com

IDEAL LUX Warehouse
Via delle Industrie, 8/D
30036 Santa Maria di Sala (Venezia)
8.00 - 12.00 / 13.30 - 17.00

ideal lux®



REV 01/07/2020

Rhapsody SP16

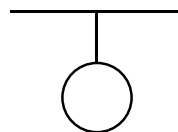

Lampada a sospensione
Suspension lamp
Suspension
Pendelleuchte
Lámpara colgante
Люстры и подвесы



max 16 x 15W G9 / 220~240V
50/60Hz
- 8021696236964 NERO

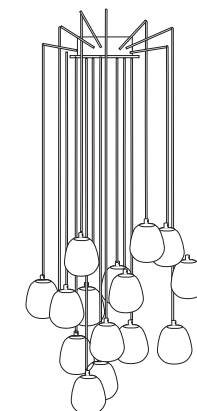

ø 95

57,5

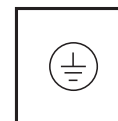
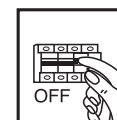

IDEAL LUX s.r.l.
Via Taglio Destro 32
30035 Mirano (VE) Italy
www.ideal-lux.com

IDEAL LUX Warehouse
Via delle Industrie, 8/D
30036 Santa Maria di Sala (Venezia)
8.00 - 12.00 / 13.30 - 17.00

ESeguire le operazioni seguendo l'ordine progressivo
FOLLOW THE ASSEMBLY INSTRUCTIONS BY READING THE NUMERICAL PROGRESSION

L'INSTALLAZIONE DI QUESTO APPARECCHIO DEVE ESSERE EFFETTUATA DA PERSONALE QUALIFICATO
THE LIGHTING FITTING SHOULD BE INSTALLED BY A QUALIFIED ELECTRICIAN

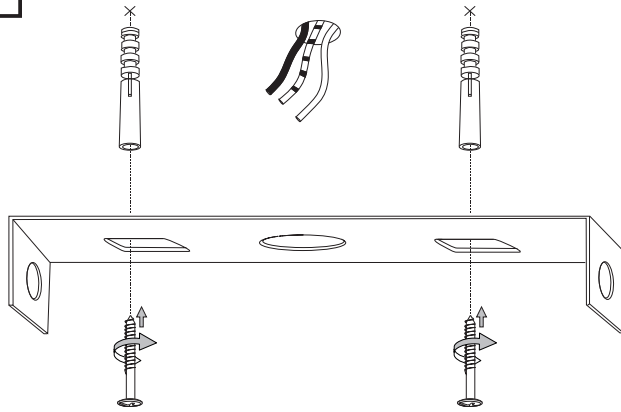
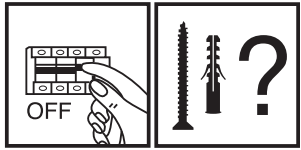

1

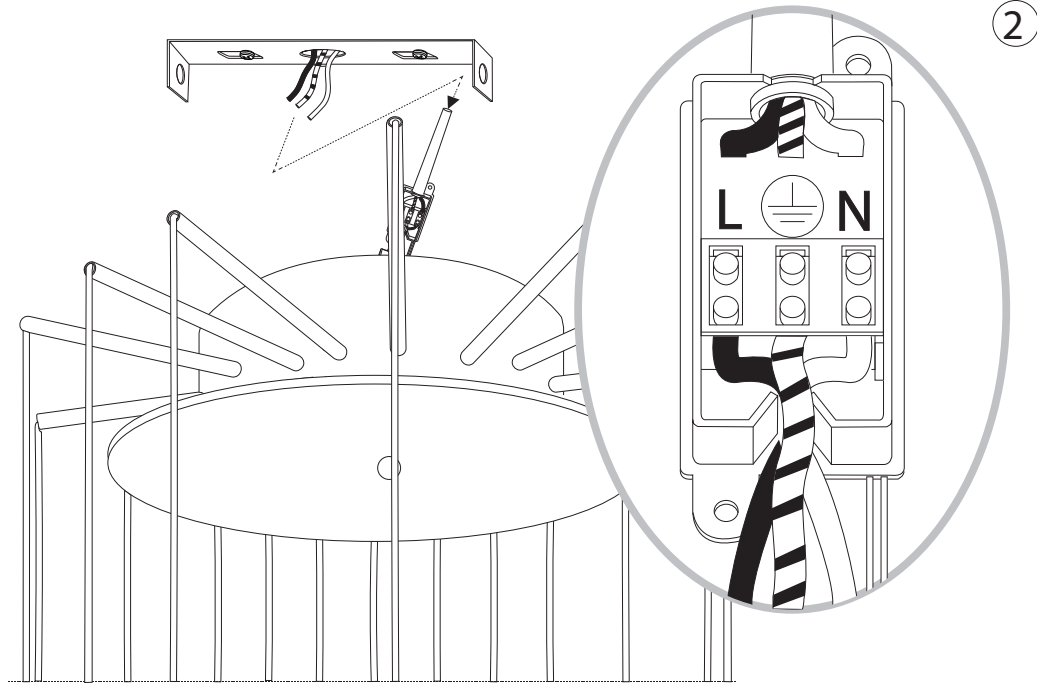

2

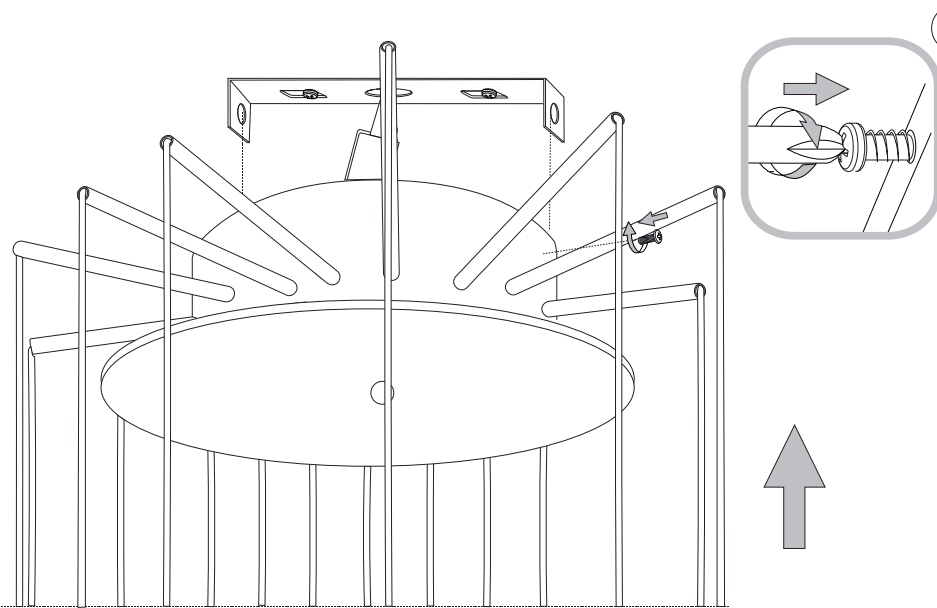

3

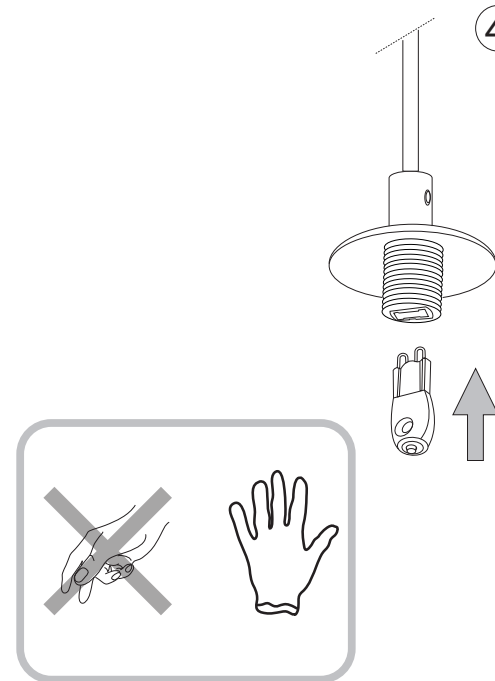

4

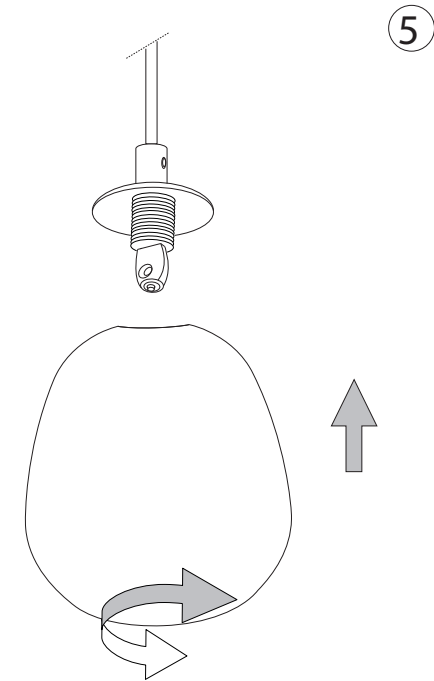

5

LA SICUREZZA DI QUESTO APPARECCHIO È GARANTITA SOLO CON L'USO APPROPRIATO DI QUESTE ISTRUZIONI, PERTANTO È NECESSARIO CONSERVARLE
THE SAFETY AND RELIABILITY ARE GUARANTEED ONLY WHEN INSTALLATION INSTRUCTIONS ARE PROPERLY FOLLOWED. PLEASE KEEP THIS INSTRUCTION SHEET FOR FUTURE REFERENCE.

