

boverinfo@boverusa.com
www.boverusa.com

Syra - 60 Outdoor

Name: Syra - 60 Outdoor

Design: Alex Fernández Camps / Gonzalo Milà / 2014

Typology: Pendant lamp

Environment: Outdoor

Technical description:

Outdoor pendant lamp. LED light source protected by an opal matt glass plate. Shade is an aluminum structure that is hand wrapped with synthetic polyethylene fiber and is available in White or Brown. Canopy is coated with anticorrosive, cataphoresis treatment to provide protection against all weather conditions. Built in accordance with IP 55 rating. Electrical cord is sleeved with protective neoprene. Height can be adjusted by tensor stainless steel wires.



Lamps description

 Grounding: compulsory

 22 W LED

Led: 66 x 0.33 W = 22 W

Lumens: 2500 lm

CRI: 90

Degrees Kelvin: 2700°

Voltage: 120-277V / 50-60Hz

 1 Box 29.53 x 29.53 x 17.72 inches

Vol.: 8.9381 ft³

Weight: 29.76 lbs

Certifications:   IP-55

 Photometrics made according to the position the lights are shown in the catalogue and price list.

Ref

Finishings

2642201100U	Structure Natural White Shade Ivory White
2642201101U	Structure Graphite Brown Shade Rattan Brown
2642204100U*	Dimming 0-10V Structure Natural White Shade Ivory White
2642204101U*	Dimming 0-10V Structure Graphite Brown Shade Rattan Brown

* Dimming ballast (DIM 0-10V)

Synthetic Polyethylene Fiber.
All Bover's synthetic fiber collection are recyclable and non-toxic for environmental sustainability.

Dry + wet location

Not Customizable

Measures

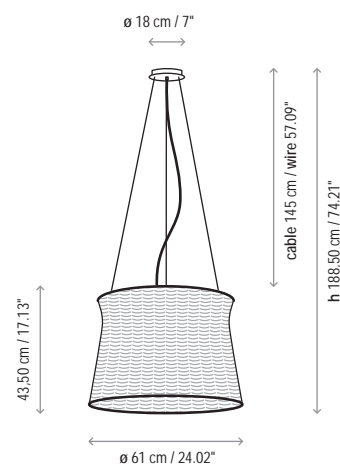

Syra - 45 Indoor

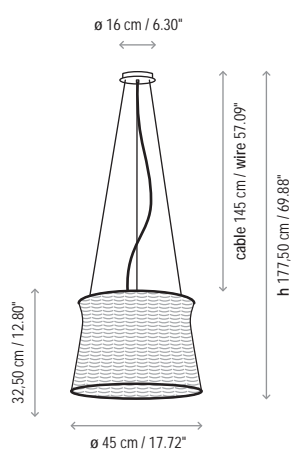

Syra - 60 Outdoor

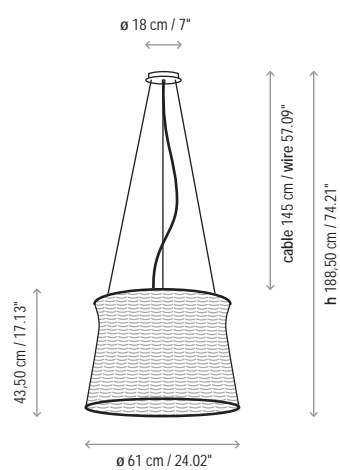

Syra - 90 Outdoor

