

PANZERI

Zero Ellipse

24V DC

M03102.130.0510

● black



Data sheet

CODE	M03102.130.0510
SYSTEM POWER CONSUMPTION	47W
EFFICACY	86.79lm/W
LIGHT SOURCE	LED
LIGHT SOURCE LIFETIME	L70 (B50) 60.000h
COLOUR TEMPERATURE	2700K Ra>90
LIGHT DISTRIBUTION	diffused
POWER SUPPLY	24V DC
DRIVER	remote not included
NOMINAL LUMINOUS FLUX	5670lm
LUMEN OUTPUT	4079lm
EFFICIENCY	71.9%
WEIGHT	1.53 Kg
PROTECTION DEGREE	IP20
COLOUR TOLLERANCES	SDCM 3
PACKING DIMENSIONS	71,0 x 136,0 x 10,0 cm



Single or multiple suspension lighting fixture for interiors, with direct and indirect light emission.

Bended extruded aluminium structure in white, black, bronze, mat brass or titanium polyacrylic paint.

Extruded polycarbonate diffuser with opaline finish.

Suspension kit with griplocks and 5m (196,9") long steel cables.

5m (196,9") long power cable in transparent PVC.

Provided without power canopy.

Technical drawing

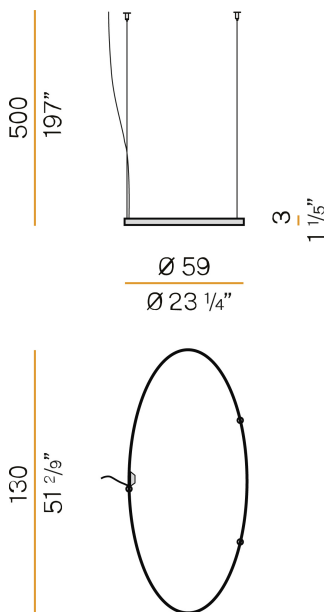

Polar diagram

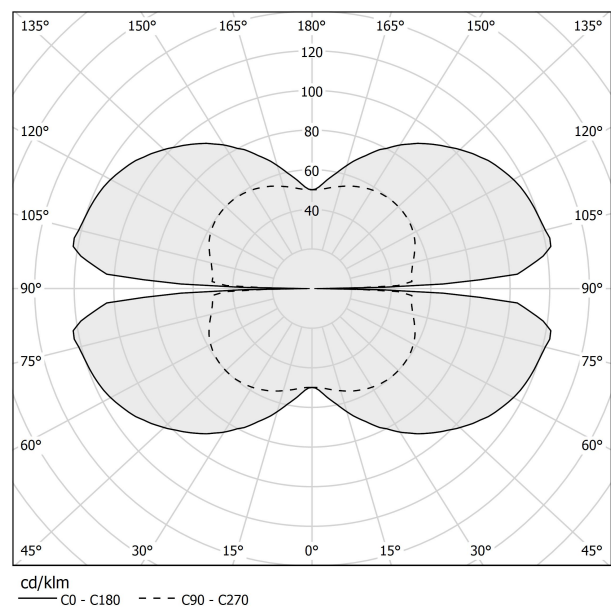

PANZERI

Zero Ellipse

Accessories / power supply

XM03302.511.0002

Canopy for power supply of 1 Zero Shapes model, with DALI/Push DIM driver.



4.1
1 9/16"



20.6
8 1/8"

XM03302.522.0002

Canopy for power supply of 2 Zero Shapes models, with DALI/Push DIM drivers.



8.8
1 1/2"



32.5
12 1/4"

XM03302.523.0002

Canopy for power supply of 3 Zero Shapes models, with DALI/Push DIM drivers.



8.8
1 1/2"



32.5
12 1/4"

XM03302.524.0002

Canopy for power supply of 4 Zero Shapes models, with DALI/Push DIM drivers.



8.8
1 1/2"



32.5
12 1/4"

PANZERI

Zero Ellipse

Accessories / power supply and fixing

XM03302.531.0002

Canopy for power supply and suspension of 1 Zero Shapes Horizontal model, with DALI/Push DIM driver.



4.1
1 7/8"



20.6
8 1/8"

XM03302.532.0002

Canopy for power supply and suspension of 2 Zero Shapes Horizontal models, with DALI/Push DIM drivers.



3.8
1 1/2"



32.5
12 5/8"

XM03302.533.0002

Canopy for power supply and suspension of 3 Zero Shapes Horizontal models, with DALI/Push DIM drivers.



3.8
1 1/2"



32.5
12 5/8"

XM03302.534.0002

Canopy for power supply and suspension of 4 Zero Shapes Horizontal models, with DALI/Push DIM drivers.



3.8
1 1/2"



32.5
12 5/8"

XM03402.552.0002

Canopy for power supply and suspension of 1 Zero Shapes Horizontal and 1 Zero Round Vertical models, with DALI/Push DIM drivers.



3.8
1 1/2"



39.5
15 9/16"

XM03402.553.0002

Canopy for power supply and suspension of 2 Zero Shapes Horizontal and 1 Zero Round Vertical models, with DALI/Push DIM drivers.



3.8
1 1/2"



39.5
15 9/16"

XM03402.554.0002

Canopy for power supply and suspension of 2 Zero Shapes Horizontal and 2 Zero Round Vertical models, with DALI/Push DIM drivers.



3.8
1 1/2"



39.5
15 9/16"