

WOOD suspension

Matteo Ugolini design

ООО "Мастерская светотехники"
8 800 100 39 72
8 495 727 14 91
9725087@masv.ru
http://masv.ru

year 2009

TECHNICAL SHEET - SE611-2B

STRUCTURE "A"

material ceramic
colour white



CEILING CUP "E"

material metal
colour glossy white

ELECTRICAL CABLE "C"

material PVC
colour transparent

SUSPENSION CABLE "F"

material steel

ELECTRICAL SYSTEM

socket GU10
source max 1x7w, LED
energy class from A to A++

PACKAGING

nr. of collis 1
net weight/kg 2,6
gross weight/kg 3,7
packaging/cm 17x17x122

EMISSION OF LIGHT

unidirectional

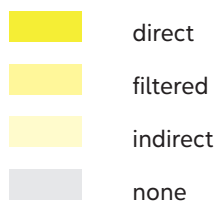
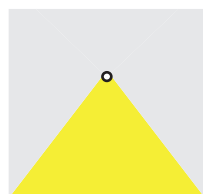

CERTIFICATION

IEC 60598-1:2008
EN 60598-1:2008 + A11:2009



ip rate IP20
bulb equipped



GU10 LED
7w - 450 lumen - 3000 K°

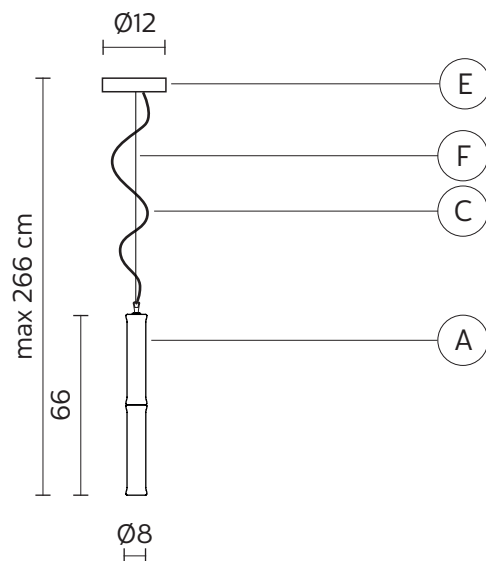

COLLECTION

