

- Track mounted LED projector
- Aluminium body machined from solid in 6082 alloy with polyester powder paint resistant to corrosion
- Tempered, extraclear, anti-glare safety glass with grinded edges
- Beam angles 20° 30° 48° 86°
- Adjustable pan and tilt movements
- Power supply integrated in the track adapter
- Compatible with three-phase Eurostandard tracks
- Maximum permissible ambient temperature + 35°C

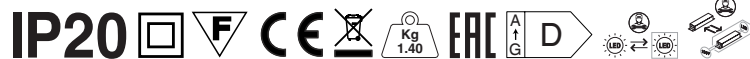

- *Proiettore LED a binario*
- *Corpo in alluminio tornito dal pieno lega 6082 con verniciatura in polvere di poliestere resistente alla corrosione*
- *Vetro di sicurezza temperato con bordi molati, extrachiario ed antiriflesso*
- *Angoli del fascio 20° 30° 48° 86°*
- *Orientabile in senso orizzontale e verticale*
- *Alimentatore integrato nell'adattatore per binario*
- *Compatibile con binari Eurostandard trifase*
- *Temperatura ambiente massima ammissibile +35°C*

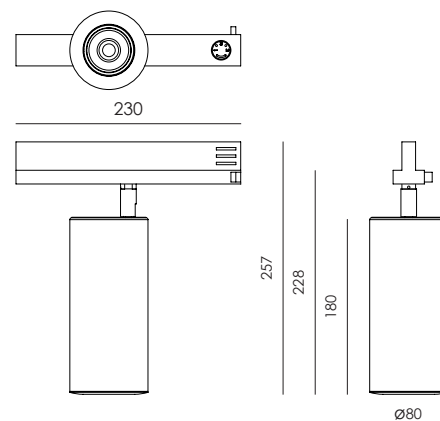

Lamp / Lampada	Input / Alimentazione	Power / Potenza	Color Tolerance / Tolleranza Cromatica	CRI / CRI
1 LED COB CREE	220/240V 50/60Hz	19 / 25 / 40 W	2-SDCM / 3-SDCM	80 MIN



NEXO LUCE (Factory)  
 Strada Mirabella, 10  
 46040 Cavriana (MN), ITALY  
 T +39 0376 771513 F +39 0376 772235  
 sales@nexoluce.com www.nexoluce.com

Made in Italy

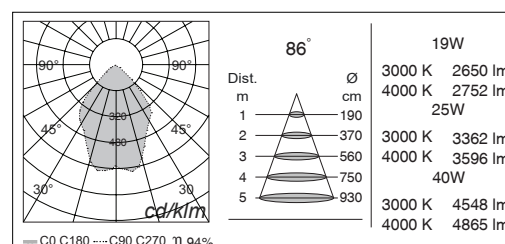
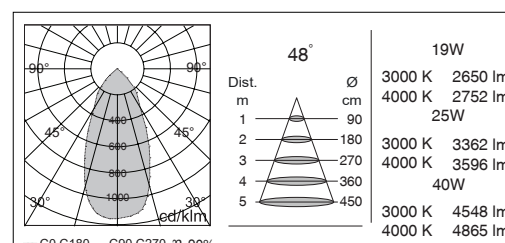
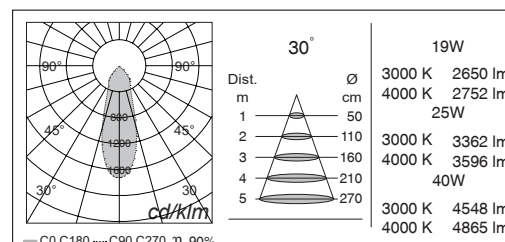
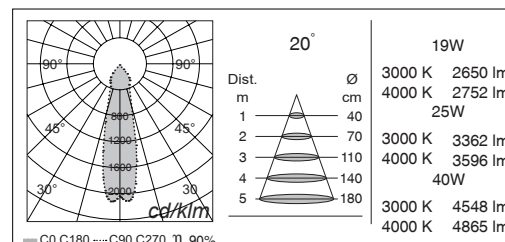
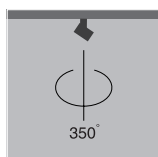
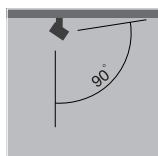
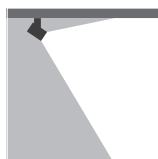

MAIN CODE CODICE BASE	RELEASE EDIZIONE	LIGHT COLOR COLORE LUCE	WATT WATT	OPTIC OTTICA	CONTROL CONTROLLO	FRAME COLOR COLORE
<b>2658</b>	<b>.1</b>	<b>B</b> 3000K	<b>.19</b> 19W	<b>.D</b> 20°	<b>1</b> ON/OFF	<b>BS</b> WHITE / BIANCO
		<b>C</b> 4000K	<b>.25</b> 25W	<b>.F</b> 30°		<b>BT</b> BLACK/ NERO
		* others on request / altri su richiesta	<b>.40</b> 40W	<b>.I</b> 48°		
				<b>BZ</b> 86°		

CODE EXAMPLE : Projector with warm white light color at 3000K, 40W, 20° optic, ON/OFF control, white color  
2658.1B.40.D1BS

ESEMPIO DI CODIFICA : Proiettore con luce calda a 3000K, 40W, ottica 20°, controllo ON/OFF, colore bianco  
2658.1B.40.D1BS

NEXO LUCE (Factory)  
Strada Mirabella, 10  
46040 Cavriana (MN), ITALY  
T +39 0376 771513 F +39 0376 772235  
sales@nexoluce.com www.nexoluce.com

Made in Italy