

SETTENANI COLLECTION "BRONTOLO" suspension

Matteo Ugolini design

year 2014

TECHNICAL SHEET - SE683N3-EXT

STRUCTURE "A"

material	concrete	
colour	grey	

ELECTRICAL CABLE "C"

material	neoprene	
colour	green	

ELECTRICAL SYSTEM

source	kit led
energy class	from A to A++





PACKAGING

nr. of collis	1
net weight/kg	6,25
gross weight/kg	7,35
packaging/cm	35x35x38

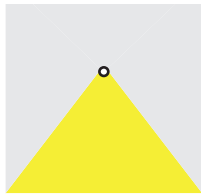
EMISSION OF LIGHT

one-directional



	direct
	filtered
	indirect
	none

CERTIFICATION

IEC	60598-1:2008
EN	60598-1:2008 + A11:2009



IP rate	IP65
bulb	equipped
	KIT LED 17,5w
	700 lumen - 3200 K°

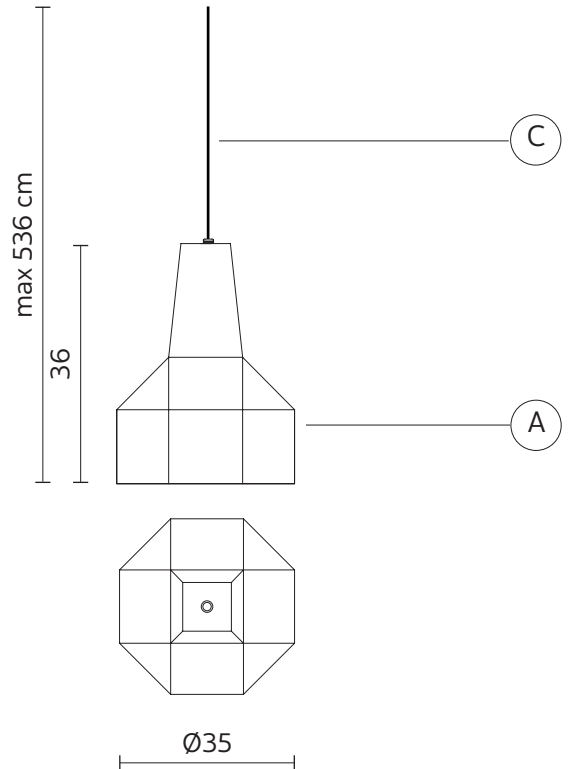

COLLECTION

available also as: table lamp and floor lamp

