

Name: Urban PF/90

Design: Joana Bover / 2011

Typology: Ceiling lamp







Environment: Indoor

Technical description:

Ceiling lamp releasing diffused light through a chrome fixture with hand wrapped translucent polyester blend ribbon. The frosted polycarbonate diffuser is included, and clients can choose among white, cream or red ribbon options.



Lamps description

-  Grounding: compulsory
-  4 x 24 W 2G11 Twin CFL
- Voltage: 120-277 V / 50-60 Hz
-  1 Box 37.40 x 37.40 x 17.72 inches
- Vol.: 14.3413 ft<sup>3</sup>
- Weight: 39.68 lbs
- Certifications:  
-  Photometrics made according to the position the lights are shown in the catalogue and price list.

Ref	Finishings
0432506BU	Chrome White Translucent Ribbon
0432506CU	Chrome Cream Translucent Ribbon
0432506RU	Chrome Red Translucent Ribbon
D0432506BU	DIM 0-10V / Chrome White Translucent Ribbon
D0432506CU	DIM 0-10V / Chrome Cream Translucent Ribbon
D0432506RU	DIM 0-10V / Chrome Red Translucent Ribbon

Measures

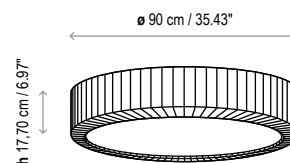

\* Dimming ballast (DIM 0-10V)

Customizable

Urban PF/37

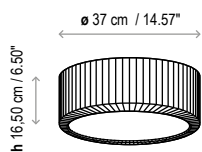

Urban PF/60

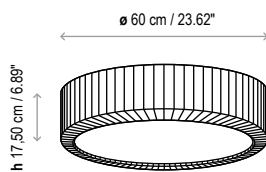

Urban PF/90

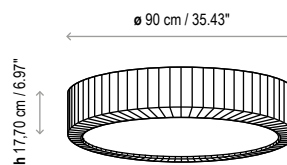

Urban PF/120

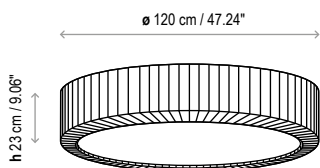

Urban S/37

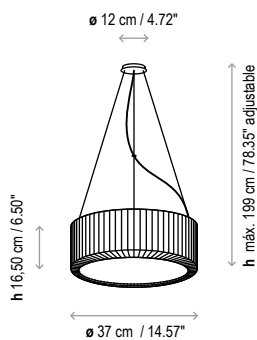

Urban S/60

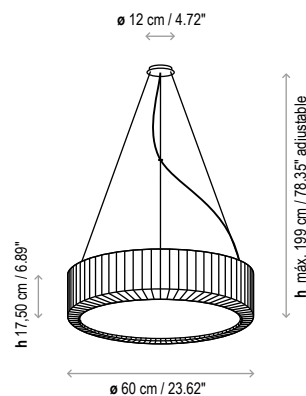

Urban S/90

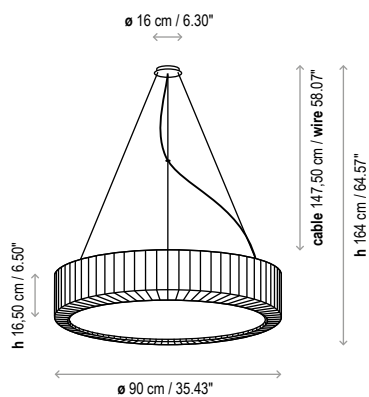

Urban S/120

