

PANZERI

Zero Round

24V DC
M03301.075.0410

● white



Data sheet

| | |
|--------------------------|-----------------------|
| CODE | M03301.075.0410 |
| SYSTEM POWER CONSUMPTION | 36W |
| EFFICACY | 84.97lm/W |
| LIGHT SOURCE | LED |
| LIGHT SOURCE LIFETIME | L70 (B50) 60.000h |
| COLOUR TEMPERATURE | 3000K Ra>90 |
| LIGHT DISTRIBUTION | diffused |
| POWER SUPPLY | 24V DC |
| DRIVER | remote not included |
| NOMINAL LUMINOUS FLUX | 4252lm |
| LUMEN OUTPUT | 3059lm |
| EFFICIENCY | 71.9% |
| WEIGHT | 1,12 Kg |
| PROTECTION DEGREE | IP20 |
| COLOUR TOLLERANCES | SDCM 3 |
| PACKING DIMENSIONS | 83,0 x 83,0 x 10,0 cm |



Single or multiple suspension lighting fixture for interiors, with direct and indirect light emission.

Bended extruded aluminium structure in white, black, bronze, mat brass or titanium polyacrylic paint.

Extruded polycarbonate diffuser with opaline finish.

Suspension kit with griplocks and 5m (196,9") long steel cables.

5m (196,9") long power cable in transparent PVC.

Provided without power canopy.

Technical drawing

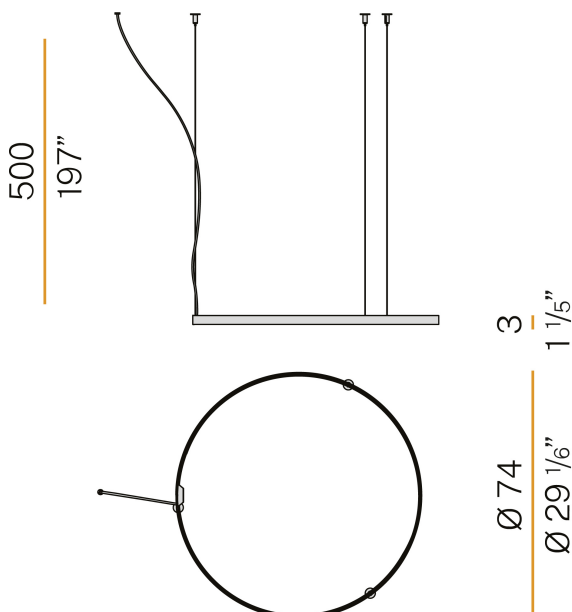

Polar diagram

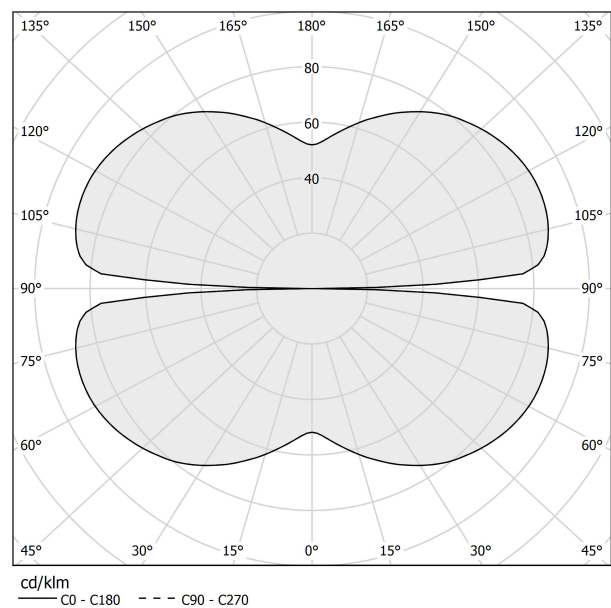

PANZERI

Zero Round

Accessories / power supply

XM03301.511.0002

Canopy for power supply of 1 Zero Shapes model, with DALI/Push DIM driver.



4.1
1 9/16"



20.6
8 1/8"

XM03301.522.0002

Canopy for power supply of 2 Zero Shapes models, with DALI/Push DIM drivers.



3.8
1 1/2"



32.5
12 1/4"

XM03301.523.0002

Canopy for power supply of 3 Zero Shapes models, with DALI/Push DIM drivers.



3.8
1 1/2"



32.5
12 1/4"

XM03301.524.0002

Canopy for power supply of 4 Zero Shapes models, with DALI/Push DIM drivers.



3.8
1 1/2"







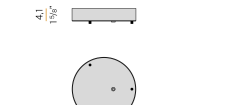

32.5
12 1/4"

PANZERI

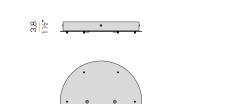
Zero Round

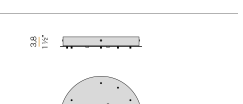
Accessories / power supply and fixing

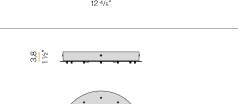
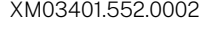
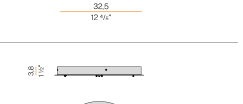
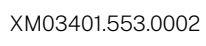
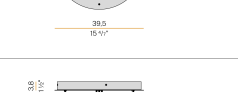
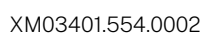
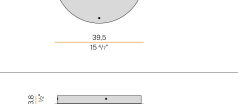
| | | |
|------------------|--|--|
| XM03301.531.0002 | Canopy for power supply and suspension of 1 Zero Shapes Horizontal model, with DALI/Push DIM driver. |   20.6 8 1/8" |
| XM03301.532.0002 | Canopy for power supply and suspension of 2 Zero Shapes Horizontal models, with DALI/Push DIM drivers. |   32.5 1 1/4" |
| XM03301.533.0002 | Canopy for power supply and suspension of 3 Zero Shapes Horizontal models, with DALI/Push DIM drivers. |   32.5 1 1/4" |
| XM03301.534.0002 | Canopy for power supply and suspension of 4 Zero Shapes Horizontal models, with DALI/Push DIM drivers. |   32.5 1 1/4" |
| XM03401.552.0002 | Canopy for power supply and suspension of 1 Zero Shapes Horizontal and 1 Zero Round Vertical models, with DALI/Push DIM drivers. |   39.5 1 5/8" |
| XM03401.553.0002 | Canopy for power supply and suspension of 2 Zero Shapes Horizontal and 1 Zero Round Vertical models, with DALI/Push DIM drivers. |   39.5 1 5/8" |
| XM03401.554.0002 | Canopy for power supply and suspension of 2 Zero Shapes Horizontal and 2 Zero Round Vertical models, with DALI/Push DIM drivers. |   39.5 1 5/8" |