

SMILE 30W CRI90 45° 3000K

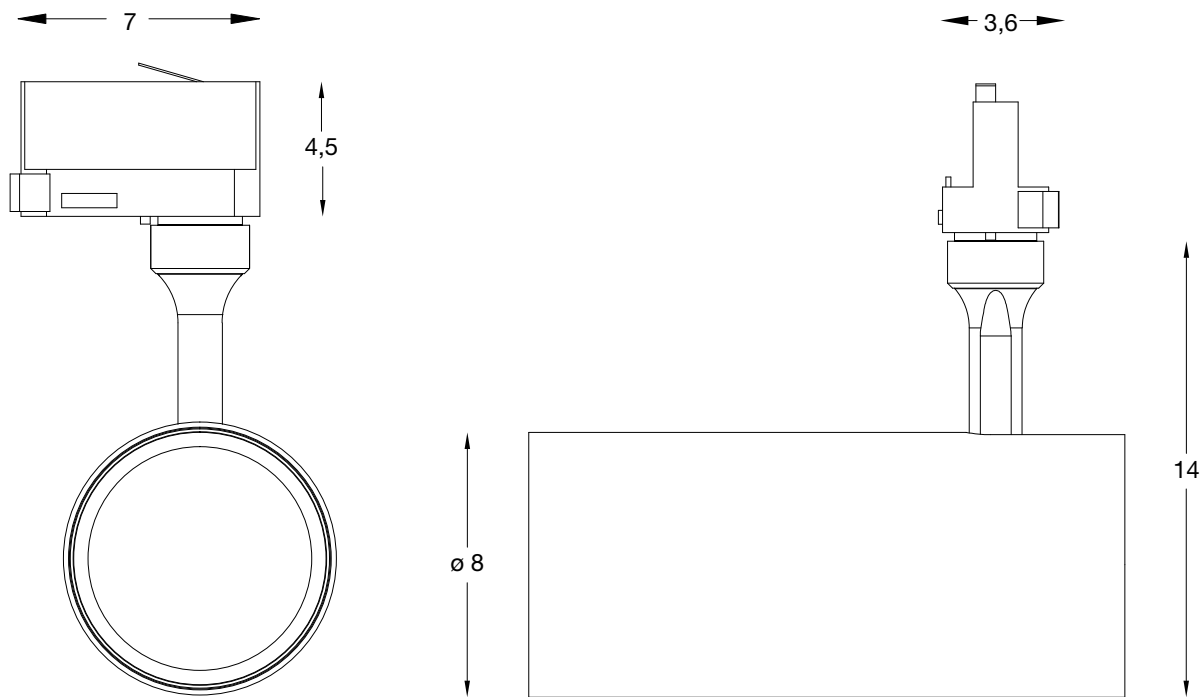

30 W



45°



2560 LM

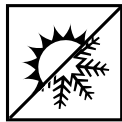

3000 K

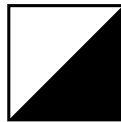

BLACK
WHITE



190105
190099



IP20

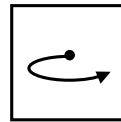

350°

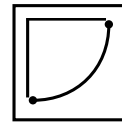

90°



≥92



4SDC

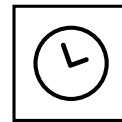

50.000 H



<9

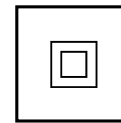

220 - 240 V

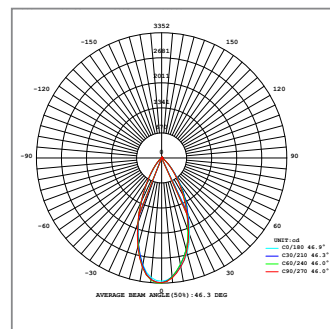
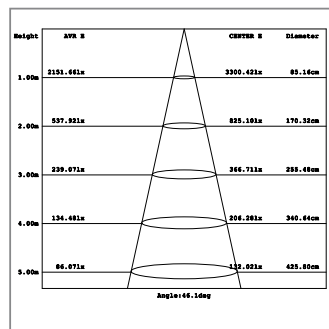
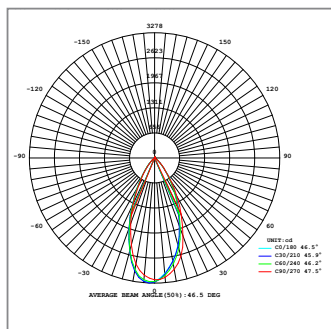
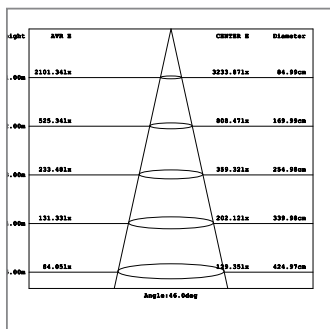
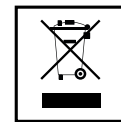



I connettori sono nascosti all'interno
Connectors are hidden inside

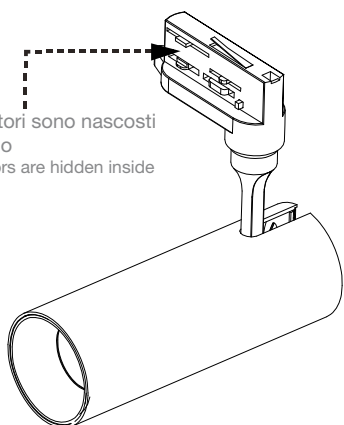

1

Assicurarsi che la leva sia posizionata lateralmente in modo che i connettori siano nascosti.
Make sure the lever is positioned sideways so that the connectors are hidden.

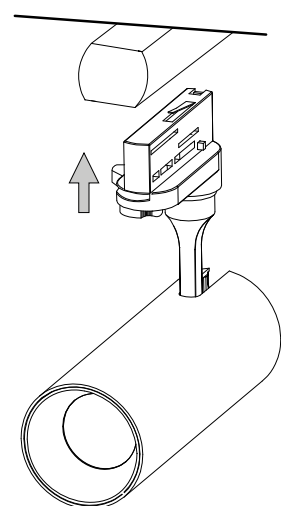

2

Inserire i connettori nel binario come illustrato.
Plug the connectors into the track as illustrated.



3

Ruotare la leva dei connettori di 90° come illustrato e bloccare il faretto.
Turn the connectors' lever 90° according to the illustrated direction and lock the light.



4

Selezionare la fase desiderata.
Select the chosen phase.



Non smontare la struttura interna della lampada.
Do not take apart the lamp's internal structure.



Non installabile su un soffitto inclinato.
Do not install on sloping ceiling.



Non installabile a muro.
Do not install on walls.

