

PANZERI

Soho S 15

48V DC ON-OFF
B70001.018.2516

● white



Data sheet

| | |
|----------------------------|-----------------------|
| CODE | B70001.018.2516 |
| SYSTEM POWER CONSUMPTION | 18W |
| EFFICACY | 94.72lm/W |
| LIGHT SOURCE | LED |
| LIGHT SOURCE LIFETIME | L80 (B10) 50.000h |
| COLOUR TEMPERATURE | 3000K Ra>90 |
| LIGHT DISTRIBUTION | flood |
| BEAM ANGLE | 30° |
| POWER SUPPLY | 48V DC |
| ELECTRICAL CONFIGURATION | ON-OFF |
| DRIVER | integrated included |
| NOMINAL LUMINOUS FLUX | 2051lm |
| LUMEN OUTPUT | 1705lm |
| EFFICIENCY | 83.1% |
| GLARE RATING | UGR < 11 |
| WEIGHT | 0.50 Kg |
| PROTECTION DEGREE | IP20 |
| GLOW WIRE TEST PERFORMANCE | 850° |
| PACKING DIMENSIONS | 11,0 x 11,7 x 29,2 cm |



Suspension lighting fixture for electrified track for interiors, with direct light emission. Die-cast aluminium structure in white or black powder paint. Reflector in thermoplastic material with chrome plated finish. Anti-glare snoot in black thermoplastic material. Die-cast aluminium end cap with powder paint. 2m (78,7") long suspension and power cable in PVC with black fabric covering. Equipped with electric and mechanical adapter for 48V low voltage electrified tracks.



Technical drawing

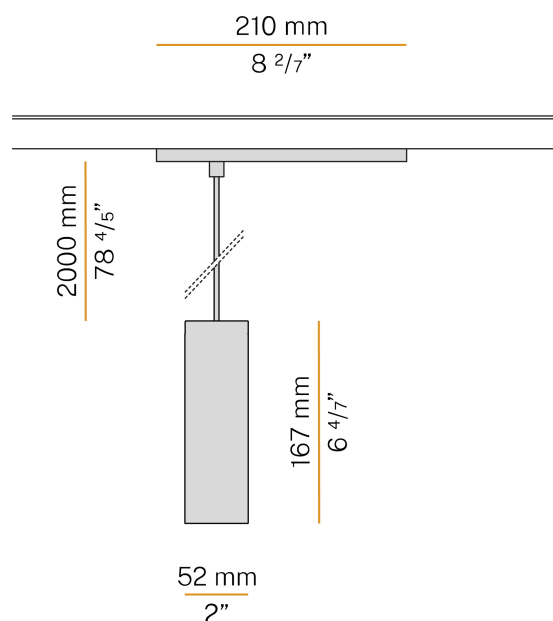

Polar diagram

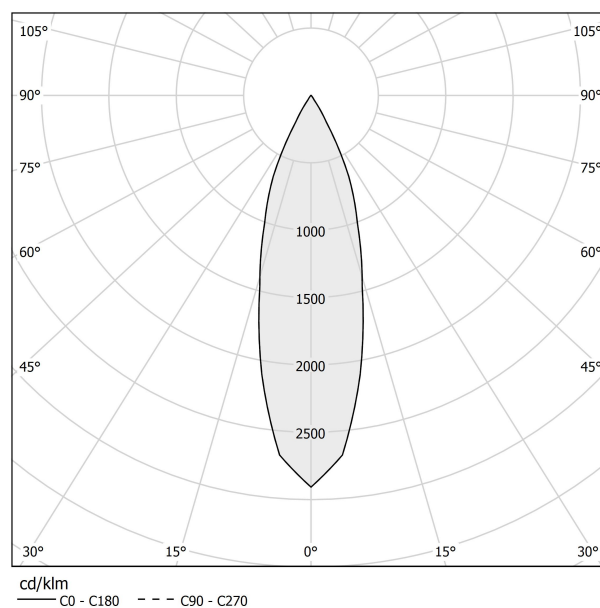

PANZERI

Soho S 15

Accessories / diffusion

XMR5

Spot optic.

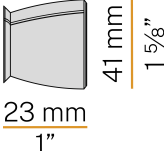

XMR7

Wide flood optic.

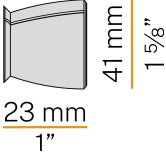

PANZERI

Soho S 15

Accessories / electrified tracks

XM44501-100



Electrified track for suspended or ceiling installation for interiors. Structure in extruded aluminium with white or black powder paint. 48V DC low voltage power supply. 15A total electrical load. Fastening, joining and closing accessories to be ordered separately. Length: 1m (39,4")

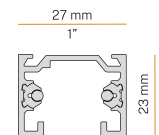

XM44501-200



Electrified track for suspended or ceiling installation for interiors. Structure in extruded aluminium with white or black powder paint. 48V DC low voltage power supply. 15A total electrical load. Fastening, joining and closing accessories to be ordered separately. Length: 2m (78,7")

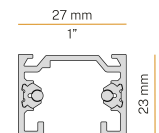

XM44501-300



Electrified track for suspended or ceiling installation for interiors. Structure in extruded aluminium with white or black powder paint. 48V DC low voltage power supply. 15A total electrical load. Fastening, joining and closing accessories to be ordered separately. Length: 3m (118,1")

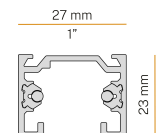

XM44602-100



Electrified track for ceiling or wall built-in installation for interiors. Total built-in structure in plasterboard, in extruded aluminium with black powder paint. 48V DC low voltage power supply. 15A total electrical load. Fastening, joining and closing accessories to be ordered separately. Length: 1m (39,4")

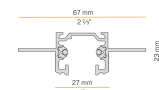

XM44602-200



Electrified track for ceiling or wall built-in installation for interiors. Total built-in structure in plasterboard, in extruded aluminium with black powder paint. 48V DC low voltage power supply. 15A total electrical load. Fastening, joining and closing accessories to be ordered separately. Length: 2m (78,7")

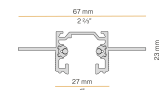

XM44602-300



Electrified track for ceiling or wall built-in installation for interiors. Total built-in structure in plasterboard, in extruded aluminium with black powder paint. 48V DC low voltage power supply. 15A total electrical load. Fastening, joining and closing accessories to be ordered separately. Length: 3m (118,1")

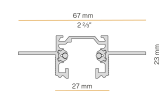

PANZERI

Soho S 15

Accessories / electrified tracks / power supply

XM445-TR

Electronic transformer, 120W 48V DC, for 48V DC electrified track.



PANZERI

Soho S 15

Accessories / electrified tracks / power supply and closing

XM44501-ADX Right live-end for 48V DC suspended or ceiling electrified track.



XM44501-ASX Left live-end for 48V DC suspended or ceiling electrified track.



XM44602-ADX Right live-end for 48V DC recessed electrified track.

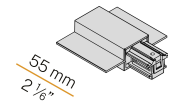

XM44602-ASX Left live-end for 48V DC recessed electrified track.

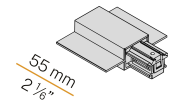

PANZERI

Soho S 15

Accessories / electrified tracks / power supply and junction

XM44501-A

Central connector for 48V DC suspended or ceiling electrified track.

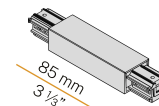

XM44602-A

Central connector for 48V DC recessed electrified track.



PANZERI

Soho S 15

Accessories / electrified tracks / closing

XM44501-C Cover 1000mm (39,4") long for 48V DC electrified track.



XM44501-E End cap for 48V DC suspended or ceiling electrified track.

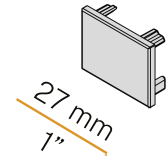

XM44502-C Cover 1000mm (39,4") long for 48V DC electrified track.



XM44602-E End cap for 48V DC recessed electrified track.



PANZERI

Soho S 15

Accessories / electrified tracks / fixing

XM44501-K

Ceiling kit for 48V DC electrified track.

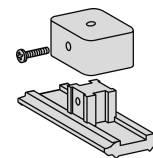

XM44501-S

Suspension kit with 2m (78,7") long steel wire and plate for 48V DC electrified track.

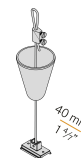

XM446-P

Plate for fixing ceiling pendants for 48V DC recessed electrified track.



PANZERI

Soho S 15

Accessories / electrified tracks / junction

XM44501-LE External "L" joint for 48V DC suspended or ceiling electrified track.



XM44501-LI Internal "L" joint for 48V DC suspended or ceiling electrified track.



XM44501-UE Straight joint for 48V DC electrified track.



XM44501-UM Mechanical straight joint for 48V DC electrified track.



XM44502-UE Straight joint for 48V DC electrified track.



XM44502-UM Mechanical straight joint for 48V DC electrified track.

