

MOROCCAN VASES | MOROCCAN VASE 2 - SUSPENDED | MOROCCAN-2-S



DESCRIPTION

A collection of petite lamps inspired by the forms and colours of Moroccan metal vases. This version is illuminated by a G9 Halogen or 3W LED lamp within a Pyrex glass ball.

PRODUCT SIZE

SHADE SIZE: 250W X 390H MM / TOTAL HEIGHT: 730MM

PACKAGING DIMENSIONS

460MM(W) X 460MM(L) X 330MM(H)



LAMP TYPE & NO

1 X G9-HALOGEN 25-60 WATT LAMPS (33-60W) OR 3W LED

CLASS II
IP RATING 54
QC RATING 21

VOLTAGE RANGE
110 - 240 V

PRODUCT MARKS & RATINGS



WEIGHT 1KG
PACKED 4KG WEIGHT

TECHNICAL DRAWING

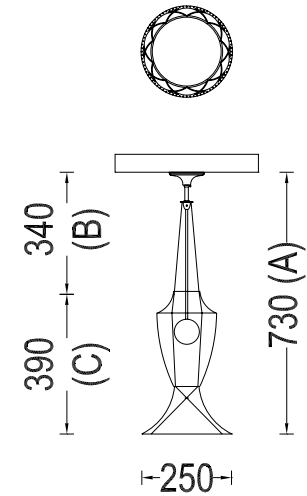

INTERACT

SELECT COLOUR

- SILVER *
- BRASS *
- COPPER *
- SMOKE *
- MIXED METALIC *
- RUST *
- WHITE
- RED
- BLACK

* METALLIC

CUSTOMISE DIMENSIONS

A

B

LAMP TYPE

QUANTITY

ADDITIONAL COMMENTS

WEB LINK