

PANZERI

Planet Ring

220-240V AC ON-OFF
L08301.100.0401

● white



Data sheet

CODE	L08301.100.0401
SYSTEM POWER CONSUMPTION	142W
EFFICACY	82.58lm/W
LIGHT SOURCE	LED
LIGHT SOURCE LIFETIME	L80 (B20) 80.000h
COLOUR TEMPERATURE	3000K Ra>90
LIGHT DISTRIBUTION	diffused
POWER SUPPLY	220-240V AC
FREQUENCY	50/60Hz
ELECTRICAL CONFIGURATION	ON-OFF
DRIVER	integrated included
NOMINAL LUMINOUS FLUX	17714lm
LUMEN OUTPUT	11727lm
EFFICIENCY	66.2%
WEIGHT	13,31 Kg
PROTECTION DEGREE	IP40
COLOUR TOLLERANCES	SDCM 3
GLOW WIRE TEST PERFORMANCE	850°
PACKING DIMENSIONS	106,0 x 106,0 x 18,0 cm



Suspension lighting fixture for interiors, with direct light emission. Pickled sheet metal structure in white polyacrylic paint. Aluminium dissipation plate. Pickled sheet metal closing frame in polyacrylic paint. Diffuser in modelled polycarbonate with opaline finish. Suspension kit with griplocks and 2m (78,7") long steel cables. 2,5m (98,4") long power cable in transparent PVC. Power canopy with galvanized sheet metal ceiling bracket and pickled sheet metal covering in white polyacrylic paint.



Technical drawing

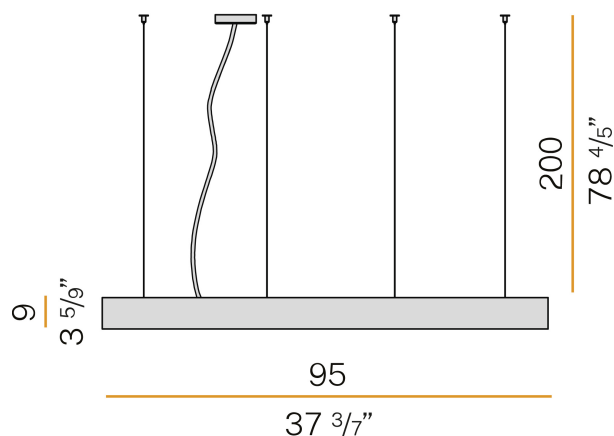

Polar diagram

