

Name: Urban S/37

Design: Joana Bover / 2011

Typology: Pendant lamp





Environment: Indoor

Technical description:

Pendant lamp with frame, finished in brilliant chrome, with a hand wrapped translucent ribbon shade in cream, white, or red. Frosted glass diffuser included. Available in four pendant formats.



Lamps description



	Grounding: compulsory
	2 x 60 W E26 A15 INC
	2 x 5 W E26 A15 LED
	2 x 14 W E26 Triple CFL

Voltage: 120V~60Hz

 1 Box 15.75 x 15.75 x 9.84 inches

Vol.: 1.4126 ft³

Weight: 11.02 lbs

Certifications:  

 Photometrics made according to the position the lights are shown in the catalogue and price list.

Ref	Finishings
410132506BU	Chrome White Translucent Ribbon
410132506CU	Chrome Cream Translucent Ribbon
410132506RU	Chrome Red Translucent Ribbon
Customizable	

Measures

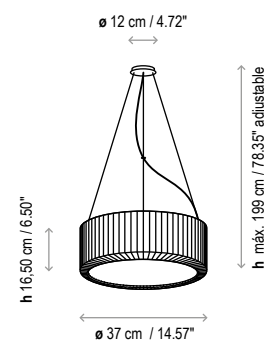

Urban PF/37

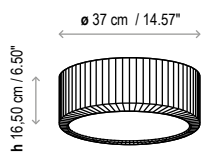

Urban PF/60

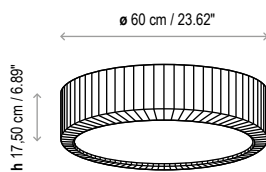

Urban PF/90

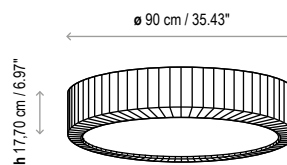

Urban PF/120

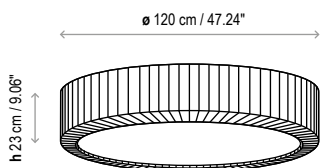

Urban S/37

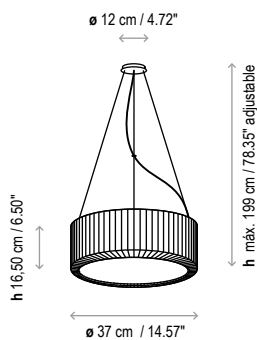

Urban S/60

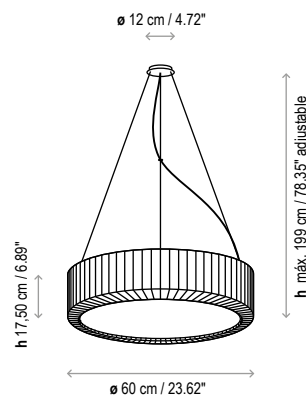

Urban S/90

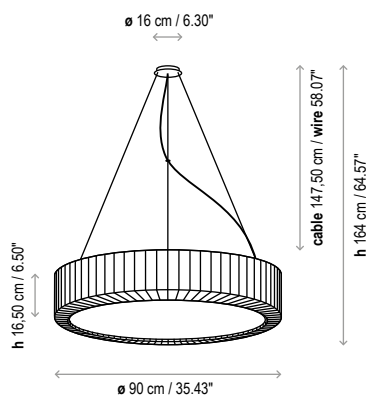

Urban S/120

