

# PANZERI

## Zero Round

24V DC  
M03319.075.0510

 mat brass



### Data sheet

CODE	M03319.075.0510
SYSTEM POWER CONSUMPTION	36W
EFFICACY	84.97lm/W
LIGHT SOURCE	LED
LIGHT SOURCE LIFETIME	L70 (B50) 60.000h
COLOUR TEMPERATURE	2700K Ra>90
LIGHT DISTRIBUTION	diffused
POWER SUPPLY	24V DC
DRIVER	remote not included
NOMINAL LUMINOUS FLUX	4252lm
LUMEN OUTPUT	3059lm
EFFICIENCY	71.9%
WEIGHT	1,12 Kg
PROTECTION DEGREE	IP20
COLOUR TOLLERANCES	SDCM 3
PACKING DIMENSIONS	83,0 x 83,0 x 10,0 cm



Single or multiple suspension lighting fixture for interiors, with direct and indirect light emission.

Bended extruded aluminium structure in white, black, bronze, mat brass or titanium polyacrylic paint.

Extruded polycarbonate diffuser with opaline finish.

Suspension kit with griplocks and 5m (196,9") long steel cables.

5m (196,9") long power cable in transparent PVC.

Provided without power canopy.

### Technical drawing

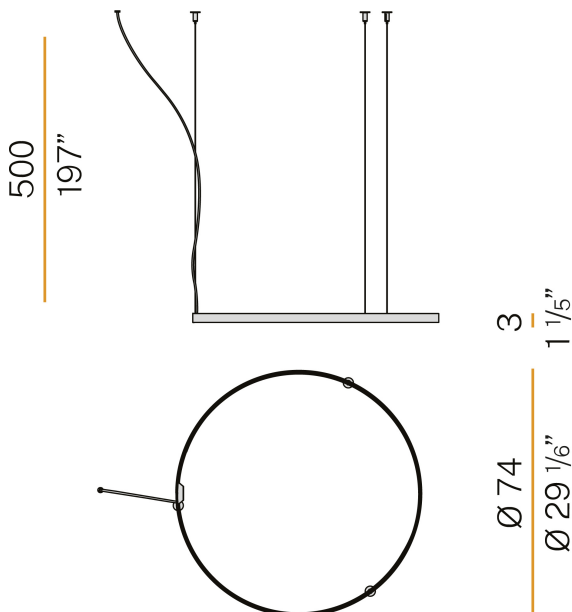

### Polar diagram

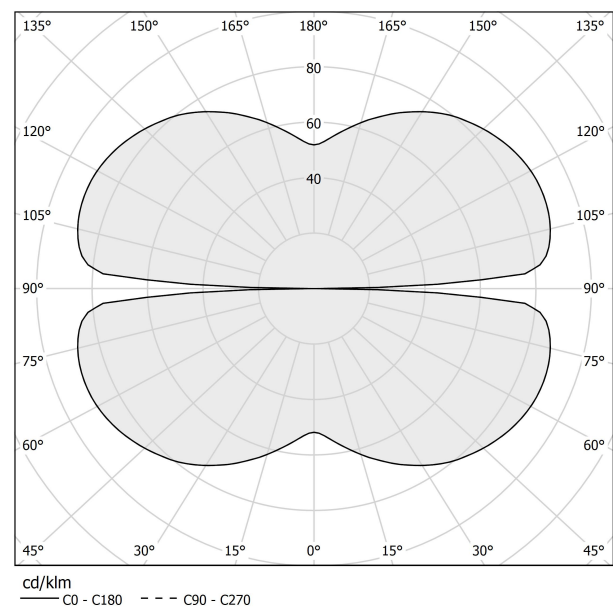

# PANZERI

## Zero Round

### Accessories / power supply

XM03319.511.0002

Canopy for power supply of 1 Zero Shapes model, with DALI/Push DIM driver.



4.1  
1 9/16"



20.6  
8 1/8"

XM03319.522.0002

Canopy for power supply of 2 Zero Shapes models, with DALI/Push DIM drivers.



8.8  
1 1/2"



32.5  
12 1/4"

XM03319.523.0002

Canopy for power supply of 3 Zero Shapes models, with DALI/Push DIM drivers.



8.8  
1 1/2"



32.5  
12 1/4"

XM03319.524.0002

Canopy for power supply of 4 Zero Shapes models, with DALI/Push DIM drivers.



8.8  
1 1/2"















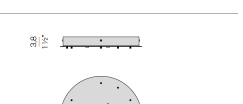

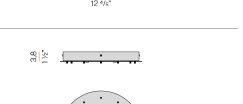
32.5  
12 1/4"

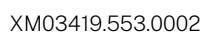
# PANZERI

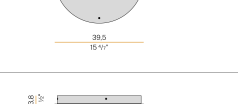
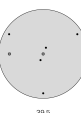
## Zero Round

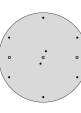
### Accessories / power supply and fixing

XM03319.531.0002 	Canopy for power supply and suspension of 1 Zero Shapes Horizontal model, with DALI/Push DIM driver.	 
XM03319.532.0002 	Canopy for power supply and suspension of 2 Zero Shapes Horizontal models, with DALI/Push DIM drivers.	 
XM03319.533.0002 	Canopy for power supply and suspension of 3 Zero Shapes Horizontal models, with DALI/Push DIM drivers.	 
XM03319.534.0002 	Canopy for power supply and suspension of 4 Zero Shapes Horizontal models, with DALI/Push DIM drivers.	 
XM03419.552.0002 	Canopy for power supply and suspension of 1 Zero Shapes Horizontal and 1 Zero Round Vertical models, with DALI/Push DIM drivers.	 
XM03419.553.0002 	Canopy for power supply and suspension of 2 Zero Shapes Horizontal and 1 Zero Round Vertical models, with DALI/Push DIM drivers.	 
XM03419.554.0002 	Canopy for power supply and suspension of 2 Zero Shapes Horizontal and 2 Zero Round Vertical models, with DALI/Push DIM drivers.	