

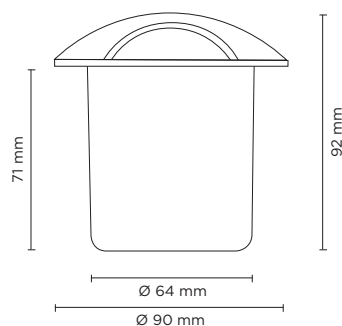

201066

HYDROFLOOR MICRO STEEL 02

Round ground-recessed drive-over luminaire for outdoor installation, top cover with two ways 2x90° light emission. Body and top cover completely realized in stainless steel AISI 304, tempered safety glass, moulded silicone gasket. Built-in LED driver 220-240V 50-60Hz, with 2 CREE XP-E2 LED. IP67 rating.



light source	light beam options	lumen output (lm)	lumin. efficacy (lm/w)
3000°K warm-white			
high-power led	 2 x 90°	250	50,00
4000°K neutral-white			
high-power led	 2 x 90°	263	52,60

Finish color options:

 Stainless Steel

Technical features



Technical data

Wattage	5 WATT
IP Rating	IP67
IK Rating	IK10
Material	Stainless steel AISI 304
Light source	NR. 2 CREE "XP-E2" LED
Screws	Stainless steel
Transformer	Electronic power supply 220/240V 50/60Hz built-in
Static weight resistance	Max 2000 Kg
Gasket	Silicone rubber
Glass	Tempered
Cable gland	M12
Power cable	1 mt. neoprene power cable included
Gross weight	1,00 Kg
Included	Polypropilene recessing box

