

ref . 29873 WHITE / BLANCO
ref . 29874 BLACK / NEGRO
1xGU10 MAX 11W no incl

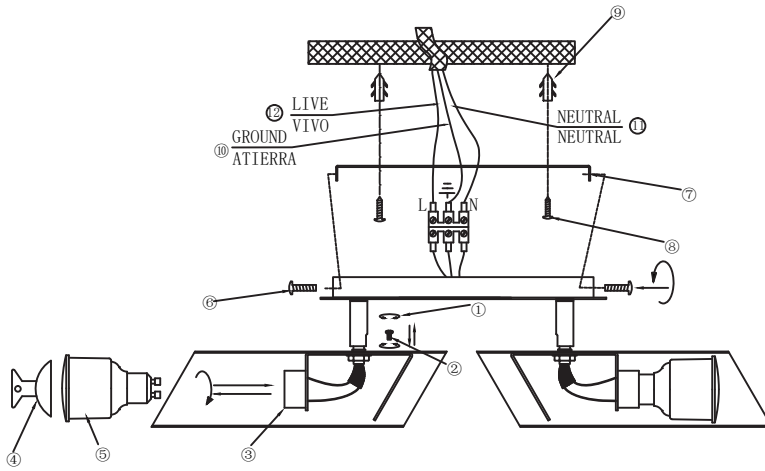

ref . 29875 WHITE / BLANCO
ref . 29876 BLACK / NEGRO
2xGU10 MAX 11W no incl



step 3

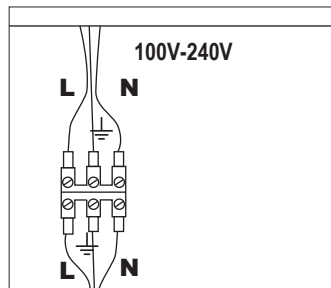

step 5

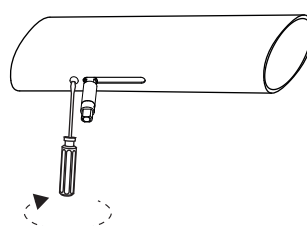
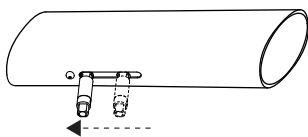
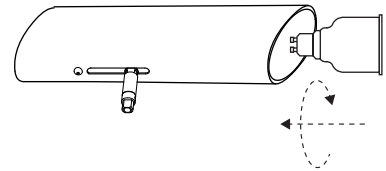
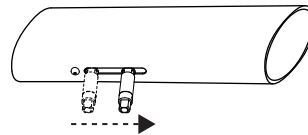
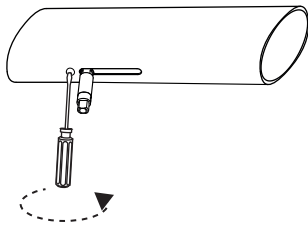

TECHNICAL FEATURES - CARACTERÍSTICAS TÉCNICAS

--	--	--	--

