

# PANZERI

## Jackie Spot

220-240V AC ON-OFF  
B07730.000.0101

● titanium



### Data sheet

CODE	B07730.000.0101
SYSTEM POWER CONSUMPTION	8,5W
EFFICACY	102.5lm/W
LIGHT SOURCE	LED
LIGHT SOURCE LIFETIME	L90 (B10) 50.000h
COLOUR TEMPERATURE	3000K Ra>80
LIGHT DISTRIBUTION	adjustable
BEAM ANGLE	90°
POWER SUPPLY	220-240V AC
FREQUENCY	50/60Hz
ELECTRICAL CONFIGURATION	ON-OFF
DRIVER	integrated included
NOMINAL LUMINOUS FLUX	1027lm
LUMEN OUTPUT	820lm
EFFICIENCY	79.8%
WEIGHT	0,66 Kg
PROTECTION DEGREE	IP40
COLOUR TOLLERANCES	SDCM 3
PACKING DIMENSIONS	16,0 x 39,0 x 16,0 cm

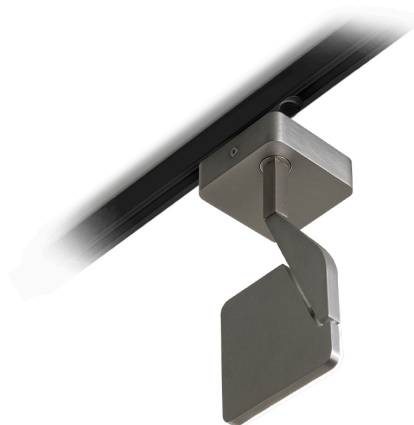

Lighting fixture for electrified track for interiors, with swivelling light beam.  
Pickled sheet metal bracket in polyacrylic paint.  
Die-cast aluminium structure in white, black, red or titanium polyacrylic paint.  
Die-cast aluminium head rotating on two axes in polyacrylic paint.  
Modelled acrylic diffuser with mat finish and double serigraphy.  
Equipped with electric and mechanical adapter for three-phase electrified tracks.



### Technical drawing

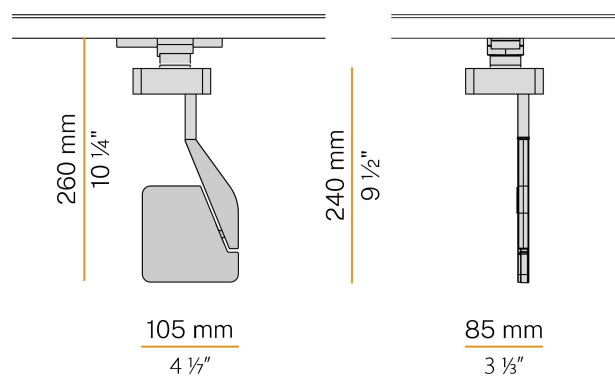

### Application



### Polar diagram

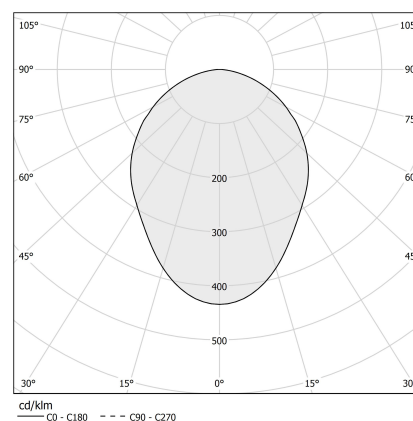

# PANZERI

## Jackie Spot

### Accessories / electrified tracks

XM7501-100



Three-phase electrified track for suspended or ceiling installation for interiors. Structure in anodized extruded aluminium or with white or black powder paint. Copper conductors housed inside extruded section bars in PVC with high isolation resistance. 230-250V AC line voltage or 380-440V AC industrial line voltage power supply. 16A total electrical load. Fastening, joining and closing accessories to be ordered separately. Length: 1m (39,4")

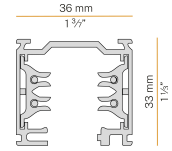

XM7501-200



Three-phase electrified track for suspended or ceiling installation for interiors. Structure in anodized extruded aluminium or with white or black powder paint. Copper conductors housed inside extruded section bars in PVC with high isolation resistance. 230-250V AC line voltage or 380-440V AC industrial line voltage power supply. 16A total electrical load. Fastening, joining and closing accessories to be ordered separately. Length: 2m (78,7")

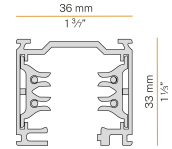

XM7501-300



Three-phase electrified track for suspended or ceiling installation for interiors. Structure in anodized extruded aluminium or with white or black powder paint. Copper conductors housed inside extruded section bars in PVC with high isolation resistance. 230-250V AC line voltage or 380-440V AC industrial line voltage power supply. 16A total electrical load. Fastening, joining and closing accessories to be ordered separately. Length: 3m (118,1")

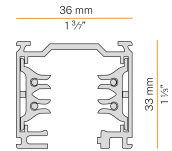

XM7502-100



Three-phase electrified track for suspended or ceiling installation for interiors. Structure in anodized extruded aluminium or with white or black powder paint. Copper conductors housed inside extruded section bars in PVC with high isolation resistance. 230-250V AC line voltage or 380-440V AC industrial line voltage power supply. 16A total electrical load. Fastening, joining and closing accessories to be ordered separately. Length: 1m (39,4")

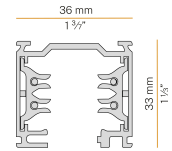

XM7502-200



Three-phase electrified track for suspended or ceiling installation for interiors. Structure in anodized extruded aluminium or with white or black powder paint. Copper conductors housed inside extruded section bars in PVC with high isolation resistance. 230-250V AC line voltage or 380-440V AC industrial line voltage power supply. 16A total electrical load. Fastening, joining and closing accessories to be ordered separately. Length: 2m (78,7")

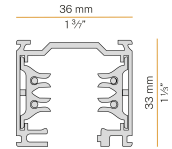

XM7502-300



Three-phase electrified track for suspended or ceiling installation for interiors. Structure in anodized extruded aluminium or with white or black powder paint. Copper conductors housed inside extruded section bars in PVC with high isolation resistance. 230-250V AC line voltage or 380-440V AC industrial line voltage power supply. 16A total electrical load. Fastening, joining and closing accessories to be ordered separately. Length: 3m (118,1")

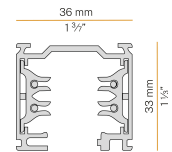

# PANZERI

## Jackie Spot

### Accessories / electrified tracks / adapters

---

XM7501

Electro/mechanical adapter 6A, mechanical load 5kg, for three-phase electrified track.



---

XM7502

Electro/mechanical adapter 6A, mechanical load 5kg, for three-phase electrified track.



---

XM76B01

Mechanical adapter with automatic locking for three-phase electrified track.

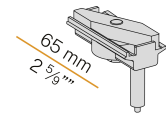

---

XM76B02

Mechanical adapter with automatic locking for three-phase electrified track.

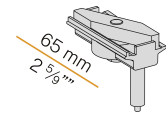

# PANZERI

## Jackie Spot

### Accessories / electrified tracks / power supply and closing

XM76ADX01

Right live-end for three-phase electrified track.

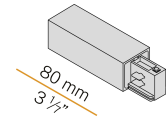

XM76ADX02

Right live-end for three-phase electrified track.

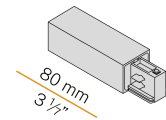

XM76ASX01

Left live-end for three-phase electrified track.

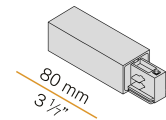

XM76ASX02

Left live-end for three-phase electrified track.

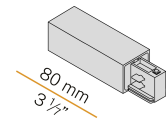

# PANZERI

## Jackie Spot

### Accessories / electrified tracks / power supply and junction

---

XM76A01

Central connector and straight joint for three-phase electrified track.

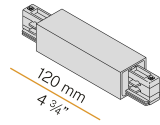

XM76A02

Central connector and straight joint for three-phase electrified track.

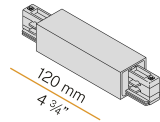

# PANZERI

## Jackie Spot

### Accessories / electrified tracks / closing

XM76C01

Cover 1000mm (39,4") long for three-phase electrified track.

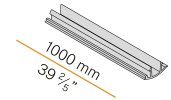

XM76C02

Cover 1000mm (39,4") long for three-phase electrified track.

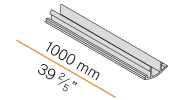

XM76E01

End cap for three-phase electrified track.

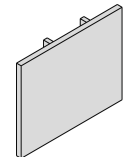

XM76E02

End cap for three-phase electrified track.

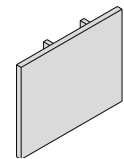

# PANZERI

## Jackie Spot

### Accessories / electrified tracks / fixing

XM76K

Ceiling kit for three-phase electrified track.

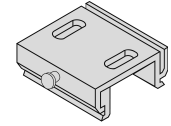

XM76S01

Suspension kit with 2m (78,7") long steel wire and plate for three-phase electrified track.

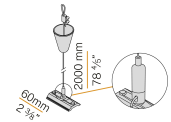

XM76S02

Suspension kit with 2m (78,7") long steel wire and plate for three-phase electrified track.

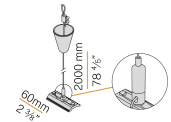

# PANZERI

## Jackie Spot

### Accessories / electrified tracks / junction

XM76F01

Flexible joint for three-phase electrified track.

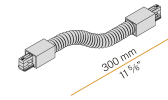

XM76F02

Flexible joint for three-phase electrified track.

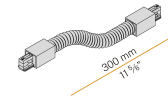

XM76LE01

External "L" joint for three-phase electrified track.



XM76LE02

External "L" joint for three-phase electrified track.



XM76LI01

Internal "L" joint for three-phase electrified track.

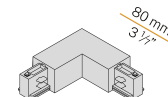

XM76LI02

Internal "L" joint for three-phase electrified track.

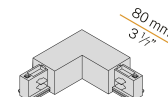

XM76M01

Mobile joint for three-phase electrified track.

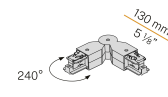

XM76M02

Mobile joint for three-phase electrified track.

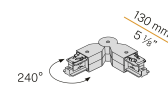

XM76Q01

Electrical straight joint with stop for three-phase electrified track.

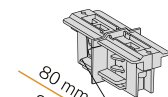



# PANZERI

## Jackie Spot

### Accessories / electrified tracks / junction

XM76Q02

Electrical straight joint with stop for three-phase electrified track.

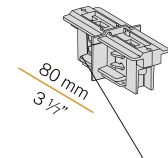

XM76TDX01

Right "T" joint for three-phase electrified track.

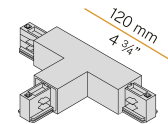

XM76TDX02

Right "T" joint for three-phase electrified track.

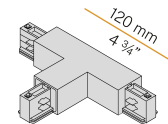

XM76TSX01

Left "T" joint for three-phase electrified track.

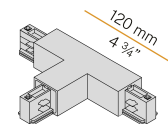

XM76TSX02

Left "T" joint for three-phase electrified track.

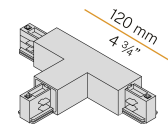

XM76U01

Mechanical straight joint for three-phase electrified track.

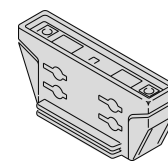

XM76U02

Mechanical straight joint for three-phase electrified track.

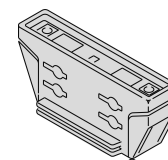

XM76X01

"X" joint for three-phase electrified track.

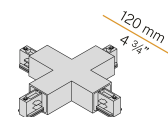

XM76X02

"X" joint for three-phase electrified track.

