

Name: Slend - Set 3 Lineal

Design: Christophe Mathieu / 2014

Typology: Pendant lamp







Environment: Indoor

Technical description:

Spun aluminum pendant in 3 separate and different shapes on 1 linear canopy. Finishes are of Brilliant Black with Black canopy, Brilliant White with white canopy or Polished Aluminum with White canopy. Copper lined aperture houses direct light source from LED lamp. Height adjustable cable in transparent for Polished Aluminum, white for Brilliant White fixtures or black for Brilliant Black fixtures.



Lamps description

 Grounding: compulsory
 3 x 5 W GU10 LED
Voltage: 120V~60Hz
 1 Box 16.14 x 20.47 x 40.55 inches
Vol.: 7.7551 ft ³
Weight: 33.07 lbs
Certifications:  
 Photometrics made according to the position the lights are shown in the catalogue and price list.

Ref	Finishings
2560620064U	Polished Aluminum White Plate Transparent Wire
2560620001U	Brilliant White White Plate White Wire
2560620023U	Brilliant Black Black Plate Black Wire
LED bulb included	
Adjustable height by the user	
Includes a fitting of each (Slend 01, 02, 03) with the same finishings.	
Special colors: RAL number to be indicated. Minimum quantity: 5 pieces.	

Measures

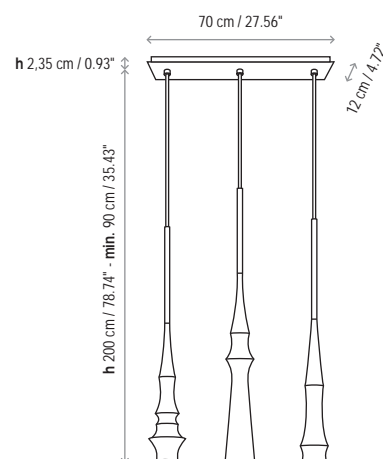

Customizable