

- the fixture is IP67 rated
- the fixture is water- and dust tight
- water should be able to flow of the product once installed
- when installed in solid ground (with or without matchbox) additional drainage must be provided (for example: a bed of gravel)
- make sure the coating (of the housing or other parts) is not damaged during installation or maintenance work: the damage can result in corrosion after contact with water
- the fixture should not be placed in road lanes, it should not be exposed to strain due to braking, acceleration and change of direction
- in order for the product to take pressure load, a proper foundation for the fixture should be provided by the client
- it is recommended to use the fixture in ground with a pH value between 5 and 8
- client should under no circumstances open the fixture themselves, in case of a problem, the fixture needs to be sent back to Kreon

1 precaution

mini up outdoor

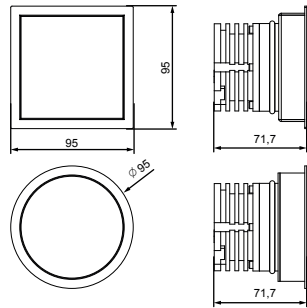

mini up in line outdoor

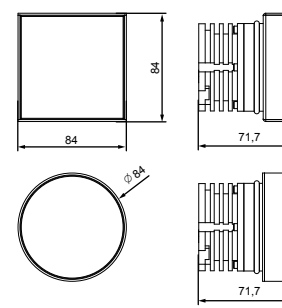

name	reference	voltage/current
mini up outdoor square diffuser	KR952101/KR952102	12V/700mA
mini up outdoor square anti-glare	KR952121/KR952122	12V/700mA
mini up outdoor square wallwasher	KR952171/KR952172	12V/700mA
mini up outdoor circular diffuser	KR952601/KR952602	12V/700mA
mini up outdoor circular anti-glare	KR952621/KR952622	12V/700mA
mini up outdoor circular wallwasher	KR952671/KR952672	12V/700mA
mini up-il outdoor square diffuser	KR952301/KR952302	12V/700mA
mini up-il outdoor square anti-glare	KR952321/KR952322	12V/700mA
mini up-il outdoor square wallwasher	KR952371/KR952372	12V/700mA
mini up-il outdoor circular diffuser	KR952801/KR952802	12V/700mA
mini up-il outdoor circular anti-glare	KR952821/KR952822	12V/700mA
mini up-il outdoor circular wallwasher	KR952871/KR952872	12V/700mA

2 dimensions

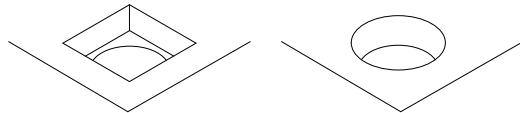

Please make sure that main voltage is disconnected before proceeding!

name	reference
matchbox square	KR752103
matchbox circular	KR752603

3 installation with matchbox

in case of installation with matchbox

NOTE:
mind that the gear cannot be placed inside the matchbox and that it has to be positioned at a distance (where it still can be reached in case of a problem)

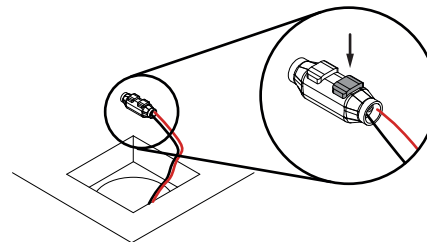

place the cable coming from the gear in the connector that's delivered with the fixture.
Close the connector on the side of the cables by applying pressure with a pliers. Don't close the other side yet!

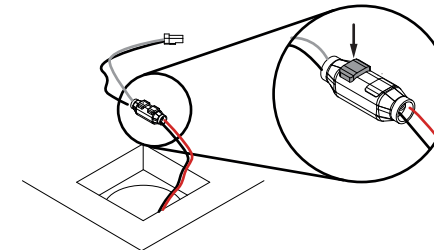

place the cable coming from the KR774005 (female connector + cable) on the other side of the blue connector.
Close the connector on that side by applying pressure with a pliers.

NOTE
Mind the polarity:
KR774005 - female connector with cable
white = +
black = -
+ of the connector must match + of the gear
- of the connector must match - of the gear

installation with matchbox

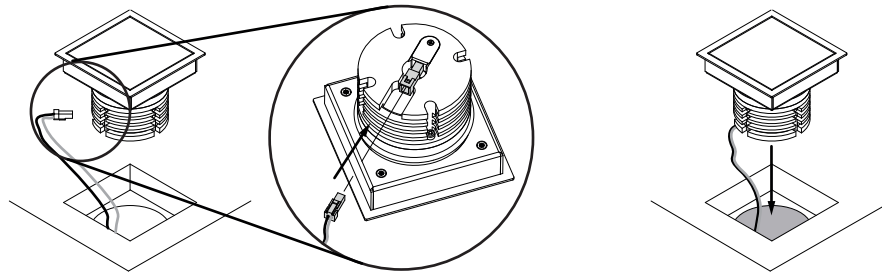

installation with matchbox

click the female connector in the male connector at the bottom of the fixture.

push the fixture in the matchbox

in case of installation in hollow floor

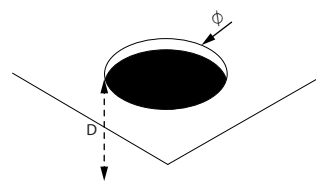
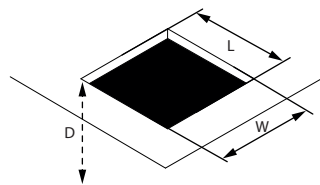

name	reference	LxWxD / ØxD
mini up outdoor square diffuser	KR952101/KR952102	85 (+2mm, -0mm) X 85 (+2mm, -0mm) X 75
mini up outdoor square anti-glare	KR952121/KR952122	85 (+2mm, -0mm) X 85 (+2mm, -0mm) X 75
mini up outdoor square wallwasher	KR952171/KR952172	85 (+2mm, -0mm) X 85 (+2mm, -0mm) X 75
mini up outdoor circular diffuser	KR952601/KR952602	Ø 85 (+2mm, -0mm) X 75
mini up outdoor circular anti-glare	KR952621/KR952622	Ø 85 (+2mm, -0mm) X 75
mini up outdoor circular wallwasher	KR952671/KR952672	Ø 85 (+2mm, -0mm) X 75
mini up-il outdoor square diffuser	KR952301/KR952302	85 (+2mm, -0mm) X 85 (+2mm, -0mm) X 72
mini up-il outdoor square anti-glare	KR952321/KR952322	85 (+2mm, -0mm) X 85 (+2mm, -0mm) X 72
mini up-il outdoor square wallwasher	KR952371/KR952372	85 (+2mm, -0mm) X 85 (+2mm, -0mm) X 72
mini up-il outdoor circular diffuser	KR952801/KR952802	Ø 85 (+2mm, -0mm) X 72
mini up-il outdoor circular anti-glare	KR952821/KR952822	Ø 85 (+2mm, -0mm) X 72
mini up-il outdoor circular wallwasher	KR952871/KR952872	Ø 85 (+2mm, -0mm) X 72

installation in hollow floor

electric connection

NOTE:
use a compatible driver with the correct required protection class
mind the dimensions of the cut-out + depth in the floor! ► if the dimensions of the driver are too big to fit through the cut-out in the floor, place the driver at a distance

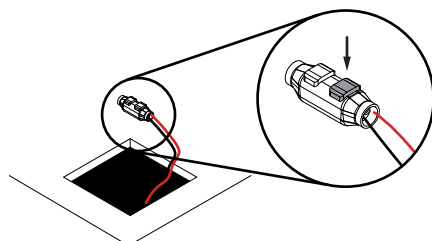

place the cable coming from the gear in the connector that's delivered with the fixture.
Close the connector on the side of the cables by applying pressure with a pliers. Don't close the other side yet!

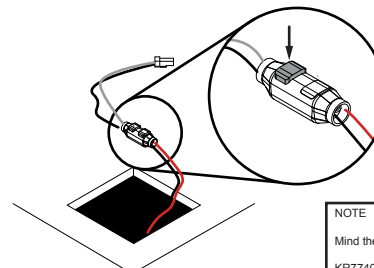

place the cable coming from the KR774005 (female connector + cable) on the other side of the blue connector.
Close the connector on that side by applying pressure with a pliers.

NOTE
Mind the polarity:
KR774005 - female connector with cable
white = +
black = -
+ of the connector must match + of the gear
- of the connector must match - of the gear

name	reference	voltage/current
mini up outdoor square diffuser	KR952101/KR952102	12V/700mA
mini up outdoor square anti-glare	KR952121/KR952122	12V/700mA
mini up outdoor square wallwasher	KR952171/KR952172	12V/700mA
mini up outdoor circular diffuser	KR952601/KR952602	12V/700mA
mini up outdoor circular anti-glare	KR952621/KR952622	12V/700mA
mini up outdoor circular wallwasher	KR952671/KR952672	12V/700mA
mini up-il outdoor square diffuser	KR952301/KR952302	12V/700mA
mini up-il outdoor square anti-glare	KR952321/KR952322	12V/700mA
mini up-il outdoor square wallwasher	KR952371/KR952372	12V/700mA
mini up-il outdoor circular diffuser	KR952801/KR952802	12V/700mA
mini up-il outdoor circular anti-glare	KR952821/KR952822	12V/700mA
mini up-il outdoor circular wallwasher	KR952871/KR952872	12V/700mA

installation in hollow floor

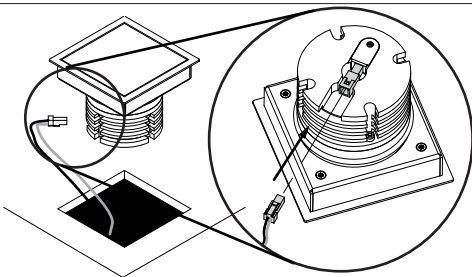

in case of mini up outdoor in case of mini up in line outdoor

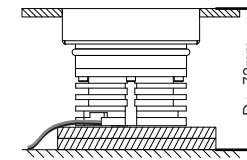
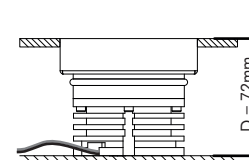
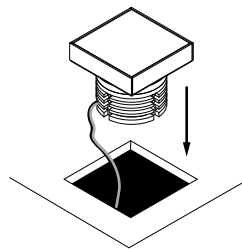
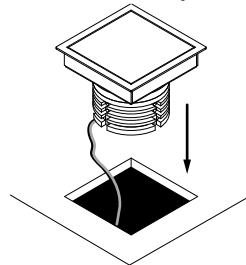

installation in hollow floor

click the female connector in the male connector at the bottom of the fixture.

place the fixture in the cut-out in the floor

if the depth in the floor is 72mm, place the fixture in the cut-out

if the depth in the floor is > 72mm, make sure to fill out the space underneath the up in line so it will be flush with the floor

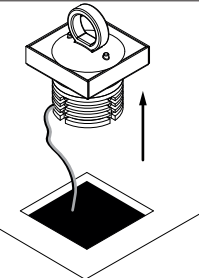
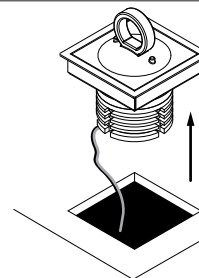
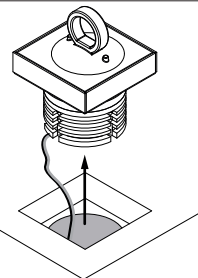
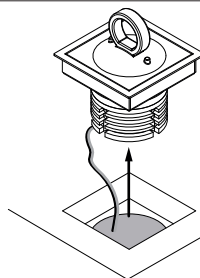
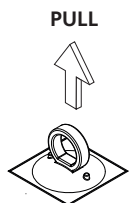
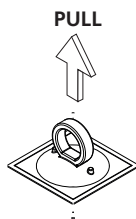

in order to take the up back out the floor: place the delivered suction cup on the glass and pull the fixture out

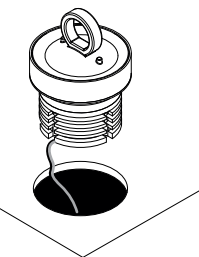
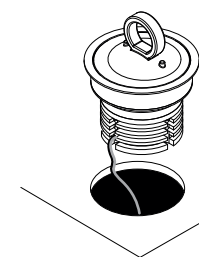
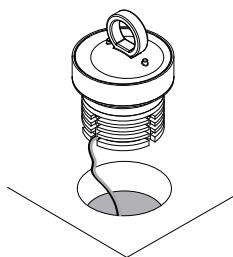
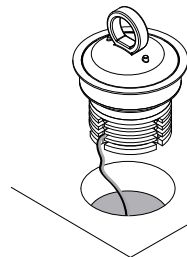

5 removal of up outdoor

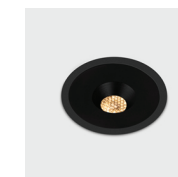
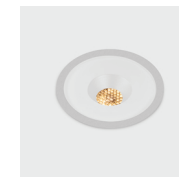
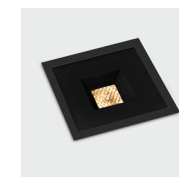
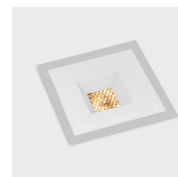
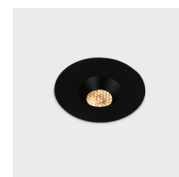
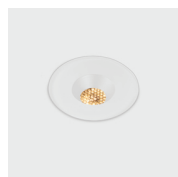
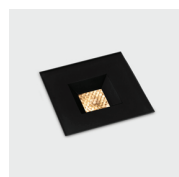

pictures

kreon nv

Industrieweg Noord 1152
B 3660 Opglabbeek
Belgium

Tel +32 89 81 97 80
Fax + 32 89 81 97 90

www.kreon.com
mailbox@kreon.be

KR8520002011
revision date: 19/12/2016

Sheet 3/3