

boverinfo@boverusa.com
www.boverusa.com**Carlota - G FL**

Name: Carlota - G FL

Design: Joana Bover / 2003







Typology: Wall lamp

Environment: Indoor

Technical description:

Wall lamp with brass structure coated in satin nickel, brilliant chrome, nickel with dark leather trim, or nickel with light caramel leather trim finishing. Square shaped lamp shade is available in cotton and white or cream translucent, hand wrapped polyester blend ribbon. The Carlota features a swivel arm that allows for easy, swift movement, as well as a brass Flexo arm with a 1.2W LED bulb. Switch is mounted on base plate, and offers three positions allowing for LED to be turned on only when main lamp is turned off. Also available in smaller size.

Lamps description

	Grounding: compulsory
	1 x 60 W E26 A15 INC
	1 x 5 W E26 A15 LED
	1 x 13 W GU24 T2 CFL
	1 x 10W GU24 A15 LED
	1 x 1.2 W LED Led: 1.2W - Optics: 45° Lumens: 85 lm Degrees Kelvin: 2900° CRI: 90

Voltage: 120V~60Hz

 1 Box 17.72 x 17.72 x 13.78 inchesVol.: 2.5038 ft³

Weight: 4.41 lbs

Certifications:   Photometrics made according to the position the lights are shown in the catalogue and price list.

Ref Finishings

F524005U	Satin nickel
F524005GU	Satin nickel / GU24
F524006U	Brilliant chrome
F524006GU	Brilliant chrome / GU24
F524060U	Nickel dark leather
F524060GU	Nickel dark leather / GU24
F524061U	Nickel caramel leather
F524061GU	Nickel caramel leather / GU24
Lampshade 9.06" x 6.69" x 4.72"	
P-487	Cotton
P-486	White translucent ribbon
P-489	Cream translucent ribbon
Surface back box 4.33" x 5.91"	
Swivel arm / brass-raw material	
Customizable	



Measures

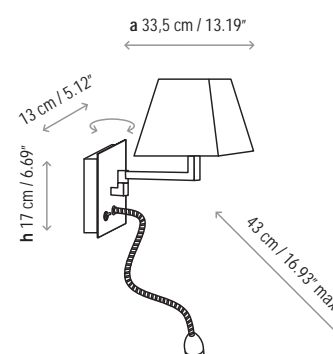

Carlota - A

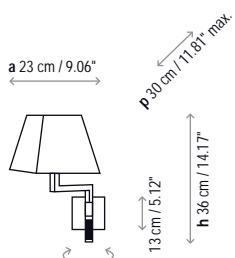

Carlota - G

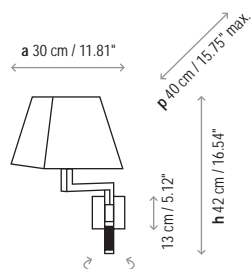

Carlota Doble Articulado

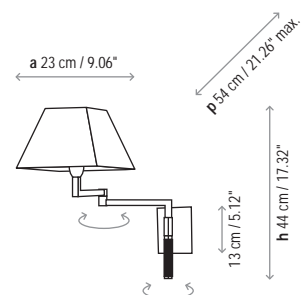

Carlota - G FL

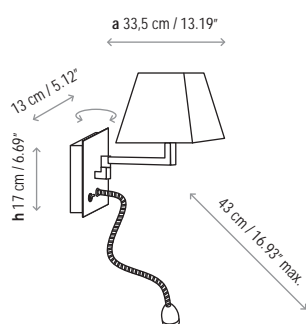

Carlota Doble FL

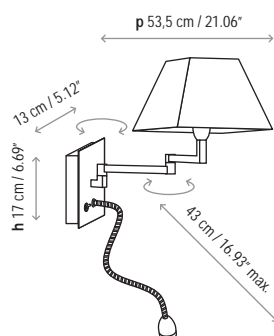

Carlota - T

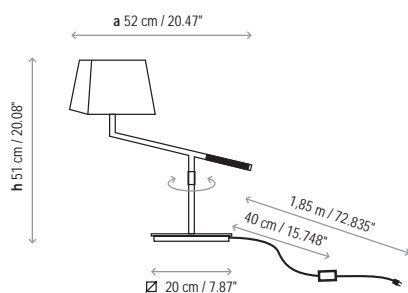

Carlota - Pie

