

- Drive-over circular LED Uplight
- Aluminium body machined from solid in 6082 alloy with surface protection treatment and subsequent polyester powder paint resistant to corrosion, atmospheric conditions and salt spray
- Brushed stainless steel frame AISI 316L
- Thermal shock resistant tempered, extraclear, anti-glare safety glass with grinded edges
- Plastic cable gland resistant to corrosion, atmospheric conditions and salt spray. Silicone gaskets
- IP67 external power supply included
- IP68 connector for the connection between projector and power supply included
- IP68 male ad female connectors and neoprene cable for connection extension (between projector and power supply) accessories available on request
- Housing for installation included. No visible screws
- One-step installation without the need to open the fixture
- Maximum permissible ambient temperature + 50° C

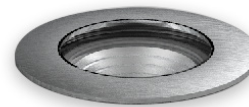

- *Proiettore LED circolare a pozzetto carrabile*
- *Corpo in alluminio tornito dal pieno lega 6082 con trattamento superficiale di protezione e successiva verniciatura in polvere di poliestere resistente agli agenti atmosferici, alla corrosione ed alle nebbie saline*
- *Cornice esterna in acciaio inox AISI 316L spazzolata*
- *Vetro di sicurezza temperato con bordi molati, extrachiario ed antiriflesso resistente agli shock termici*
- *Pressacavo in plastica resistente agli agenti atmosferici, alla corrosione ed alle nebbie saline. Guarnizioni in silicone*
- *Alimentatore esterno IP67 incluso*
- *Connettore IP68 per la connessione fra proiettore ed alimentatore incluso*
- *Connettori IP68 maschio e femmina e cavo in neoprene per prolunga connessione (fra proiettore ed alimentatore) accessori disponibili su richiesta*
- *Controcassa per installazione inclusa. Senza viti visibili*
- *Installazione in un'unica fase senza la necessità di aprire l'apparecchiatura*
- *Temperatura ambiente massima ammissibile +50° C*

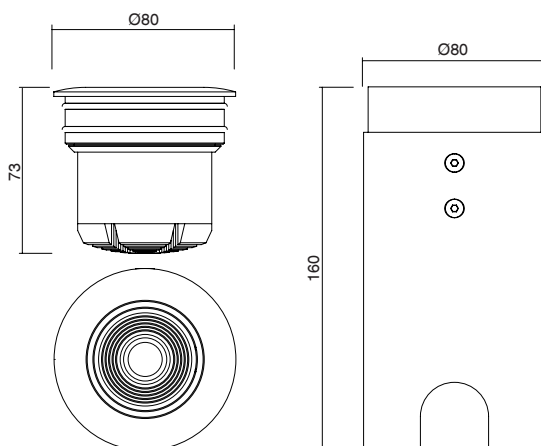

HOUSING/ CONTROCASSA



Lamp / Lampada	Input / Alimentazione	Power / Potenza	Color Tolerance / Tolleranza Cromatica	CRI / CRI
1 LED COB CREE	220/240V 50/60Hz	10 / 14W	2-SDCM / 3-SDCM	80 MIN

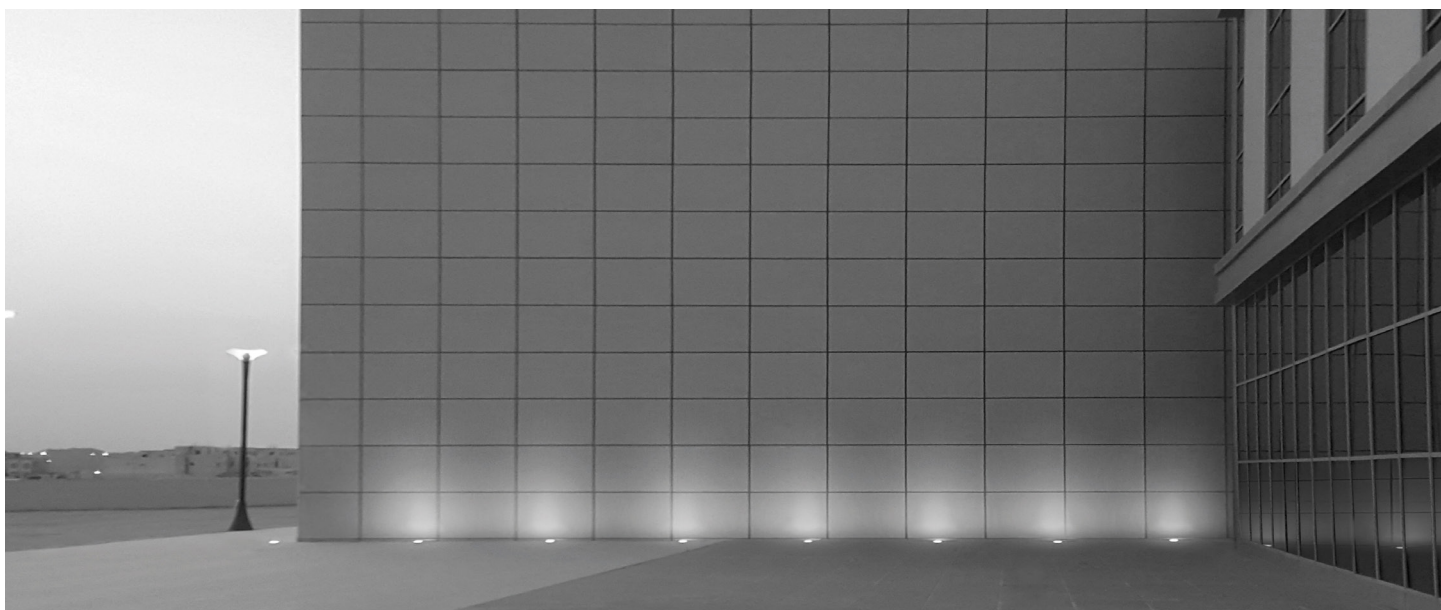

NEXO LUCE (Factory)
 Strada Mirabella, 10
 46040 Cavriana (MN), ITALY
 T +39 0376 771513 F +39 0376 772235
 sales@nexoluce.com www.nexoluce.com

Made in Italy

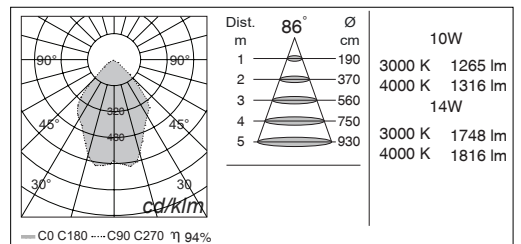
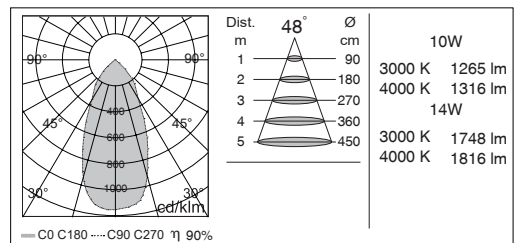
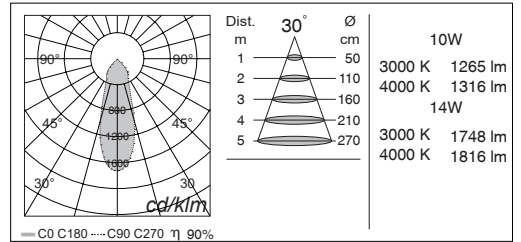
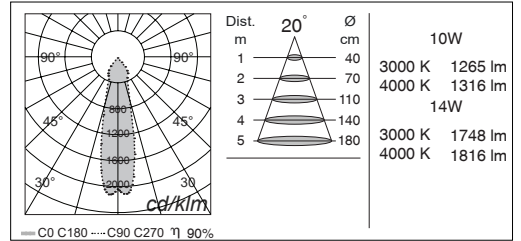
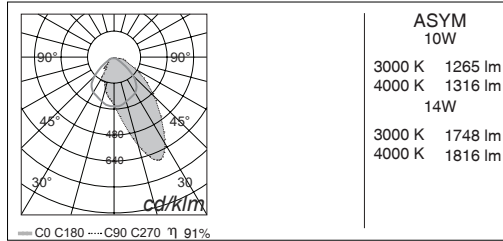

*IP68 CONNECTORS ON REQUEST
*CONNETTORI IP68 SU RICHIESTA
code: 003.0223.0



*2x0,35 H05RN-F CABLE (1 meter) ON REQUEST
*CAVO 2X0,35 H05RN-F (1 metro) SU RICHIESTA
code: 003.0224.0



MAIN CODE CODICE BASE	RELEASE EDIZIONE	LIGHT COLOR COLORE LUCE	WATT WATT	OPTIC OTTICA	CONTROL CONTROLLO	FRAME COLOR COLORE
2668	.1	B 3000K	.10 10W	.D 20°	1 ON/OFF	.G STAIN. STEEL / INOX
		C 4000K	.14 14W	.F 30°	8 DIMMER 1-10V	
		* others on request / altri su richiesta		.I 48°		
				BZ 86°		
				CX ASYM 90°x45°		

CODE EXAMPLE : Projector with warm white light color at 3000K, 10W, 20° optic, ON/OFF control, stainless steel color
2668.1B.10.D1.G

ESEMPIO DI CODIFICA : Proiettore con luce calda a 3000K, 10W, ottica 20°, controllo ON/OFF, colore inox
2668.1B.10.D1.G

NEXO LUCE (Factory)
Strada Mirabella, 10
46040 Cavriana (MN), ITALY
T +39 0376 771513 F +39 0376 772235
sales@nexoluce.com www.nexoluce.com

Made in Italy